

GLESCO-MED is committed to provide you with the highest quality surgical and dental instruments. We are the original equipment manufacturer (OEM) for instruments.

Our production depth covers thousands of instruments ranging from the typical instruments use in clinic to sophisticated instruments required during surgeries. We deem, however, pertinent to submit further that the range and scope of our production activities is not limited to our production literature. We can produce instruments even if not depicted in our online catalogues. We receive samples, photos or references from the world-renowned companies catalogues.



QUALITY/INNOVATION

At GLESCO-MED the quality is set in motion through motivated specifications planning by trained technical persons. The computer added design and imaging provide visual instruments a set configuration. This simplifies each aspect of instruments manufacturing.

QUALITY CERTIFICATIONS:

We are ISO 9001:2015, ISO 13485:2016, CE MARK approved



FORGING TO PACKING

From forging to packing each step is controlled by our trained workers to make sure that each instruments manufactured is reflecting Hilmed's craftsmanship and commitments.



LATEST TECHNOLOGIES

Our production departments are well equipped with latest machines range from latest CNC machines, laser welding and NC machines to simple drilling machines to get the ultimate quality and process control.



Extracting Forceps, American Pattern
Zahnzangen, Amerikanische Form
Daviers, forme américaine
Forceps de extracción, forma americana
Pinze per estrozione, forma americana

Page 01 to 15



Extracting forceps, English pattern
Zahnzangen, Englische Form
Daviers, forme anglaise
Fórceps dentales, forma inglesa
Pinze per estrazione, forma inglese

Page 16 - 38



Root Elevators
Wurzelheber
Elévateurs á racines
Botadores para raíces
Leve per radici

Page 40 to 54



Bone Files
Bone-Dateien
Archivos de huesos
Fichiers d'os
Bone Files

Page 55 to 56



Dental Probes
Zahnsonden
Sondas dentales
Sondes dentaires
Sonde dentali

Page 57 to 58



Enamel Instruments
Emaille-Instrumente
Instrumentos de esmalte
Instrument d'émail
Strumenti per smalto

Page 59 to 62



Dental Scalers
Zahnsteinentferner
Escaladores dentales
Scalers dentaires
Scaler dentali

Page 63 to 78



57

**Bone Curettes
Knochenküretten
Curetas de hueso
Curettes osseuses
Curette d'ossa**

Page 79 to 84



58

**Excavators
Bagger
Excavadoras
Pelles
escavatori**

Page 85 to 89



59

**Wax Proclein
Wachs-Porzellan
cera Porcelana
Cire Porcelaine
Cera porcellana**

Page 90 to 94



60

**Filling Instruments
Füllungsinstrumente
Actos de llenado
Instruments de remplissage
Strumenti di riempimento**

Page 95 to 105



61

**Gingivectomy Knives
Gingivektomie Messer
Cuchillos de gingivectomía
Couteaux de gingivectomie
Coltelli per gengivectomia**

Page 106 to 107



62

**Cement Spatulas
Zementspatel
Espátulas de cemento
Spatules de ciment
Spatole di cemento**

Page 108 to 112

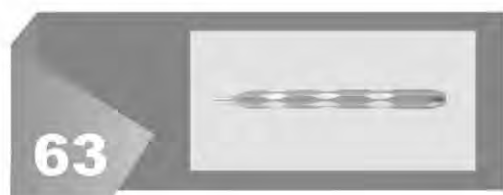

63

**Mouth Mirrors
Mundspiegel
Espejos bucales
Bouche Miroirs
Bocca specchi**

Page 113 to 115

64



Amalgam Instruments
Amalgam Instrumente
Instrumentos de amalgama
Instruments Amalgam
Strumenti amalgama **Page 116 to 117**

65



Matrix Retainers
Matrix-Halterungen
Retenedores de matrices
Retenue de matrice
Matrix Retainers **Page 118 to 125**

66



Hemostatic Forceps
Arterienklemmen
Pinces hemostaticas
Pinzashemostaticas
Pinze emostatiche **Page 126 to 132**

67



Towel Clamps
Handtuchklammern
Abrazaderas de toalla
Pinces à serviettes **Page 133 to 134**
Morsetti per asciugamano

68



Needle Holders
Nadelhalter
Porte-aiguilles
Porta-agujcs
Port' aghi **Page 135 to 143**

69



Retractors
Wundhaken
Ecarteurs
Separadores
Divaricatori **Page 144 to 148**

70



Mouth and Tongue
Mund und Zunge
Boca y la lengua
Bouche et langue
Bocca e la lingua **Page 149 to 152**



71

Scissors
 Schere
 Tijeras
 Les ciseaux
 Forbici

Page 153 to 171



72

Micro Scissors
 Mikroschere
 Micro tijeras
 Micro-ciseaux
 Micro forbici

Page 172 to 173



73

Orthodontics
 Kieferorthopädie
 Ortodoncia
 Orthodontie
 Ortodonzia

Page 174 to 190



74

Bone Rongeurs
 Knochen Rongeur
 Rongeurs de hueso
 Os Rongeurs
 Bone Rongeurs

Page 191 to 193



75

Forceps
 Zange
 Fórceps
 Forceps
 forcipe

Page 194 to 201

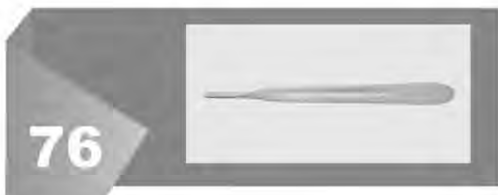

76

Scalpel Handles
 Skalpellgriffe
 Manches de bistouris
 Mangos de Bisturíes
 Manici per bisturi

Page 202 to 203



77

Mallets
 Schlägel
 Mazos
 Maillets
 Mallets

Page 204 to 206

78

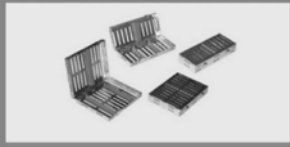

Cassettes
Kassetten
Cassettes
Cassettes
cassette

Page 207 to 210

79



Cylinder cartridge syringe
Zylinder-Ampullenspritze
Seringue á ampoule cylindrique
Jeringo para cartucho ampollas
Siringe ampollare a cilindro

Page 211 to 216

80

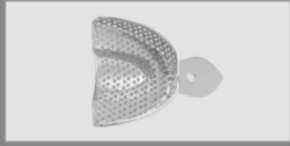

Impression Trays
Abdrucklöffel
Porte empreintes
Cubetas para impresiones
Portaimpronte

Page 217 to 228

81



Articulators
Artikulatoren
Articuladores
Articulateurs
articolatori

Page 229 to 230

82



Holloware
Holloware
holloware
Platerie
Holloware

Page 231 to 234

50

- EN** Extracting Forceps, American Pattern
- DE** Zahnzangen, Amerikanische Form
- ES** Daviers, forme américaine

Page 01 to 15

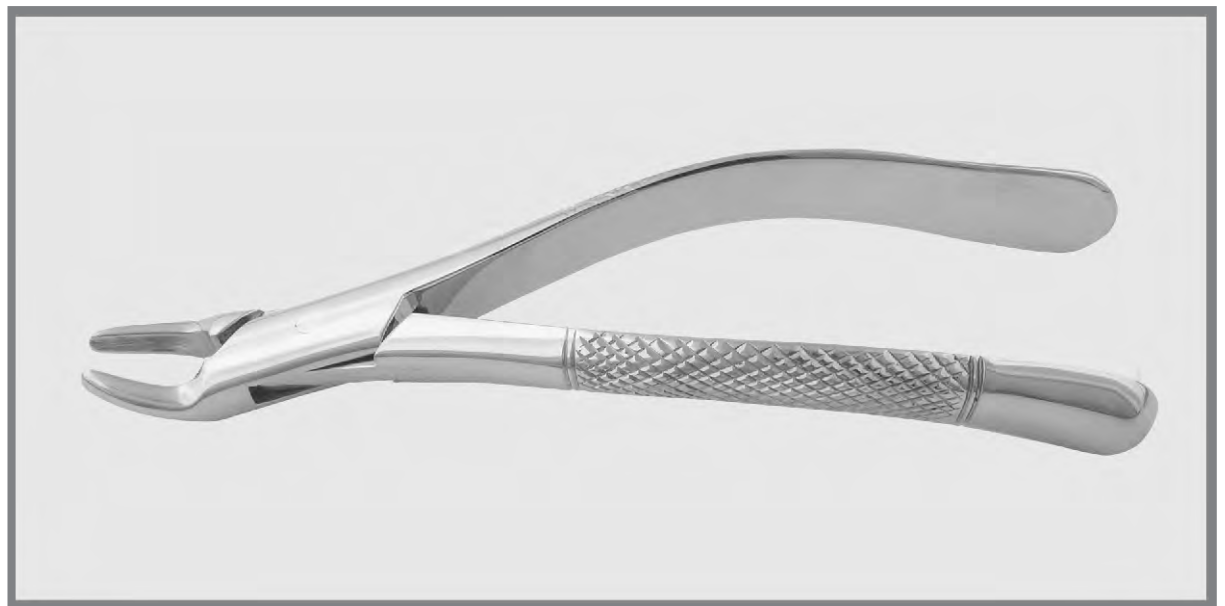



Fig. 1



GM 50-1001



HENAHAN
Fig. 1 A

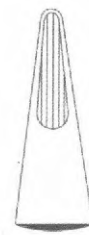

GM 50-1002



Fig. 1 B

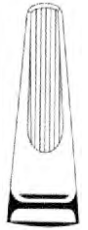

GM 50-1003



MILWAUKEE
Fig. 3



GM 50-1004



WOOD-WARD
Fig. 3 FH

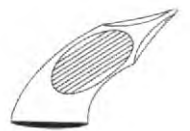

GM 50-1005



GM 50-1006

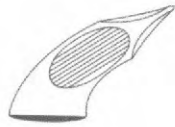

WOOD-WARD
Fig. 3 FS



GM 50-1007

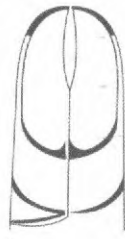

PHYSICK
Fig. 5

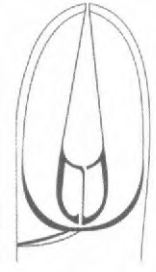

GM 50-1008

Fig. 6



GM 50-1009

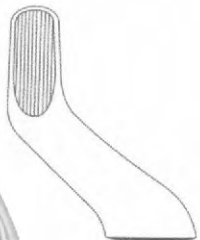

Fig . 10 H



GM 50-1010

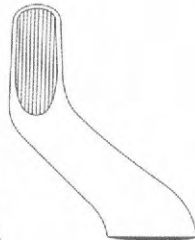

Fig . 10 S



GM 50-1011

HARRIS
Fig . 15





HARRIS
Fig. 16



GM 50-1012



Fig. 16 S



GM 50-1013



Fig. 17



GM 50-1014



HARRIS
Fig. 18 L



GM 50-1015



HARRIS
Fig. 18 R



GM 50-1016

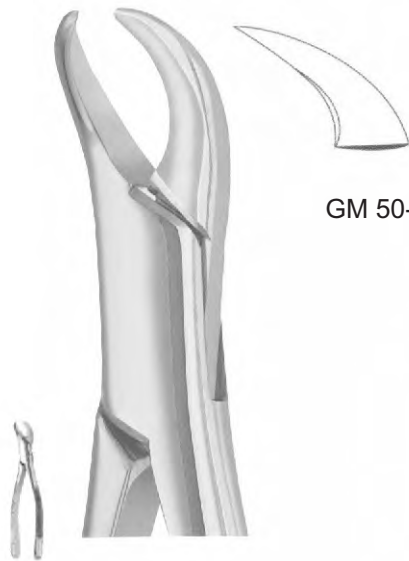

GM 50-1017

Fig. 23



GM 50-1018

Fig. 24

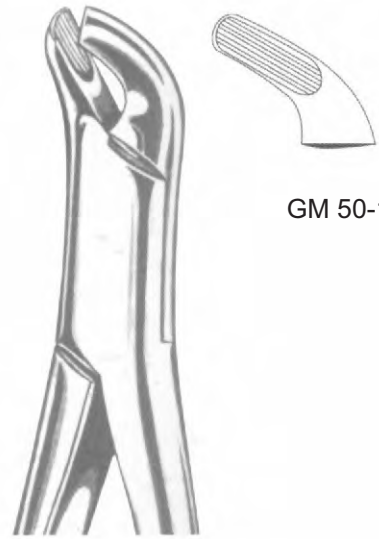

GM 50-1019

Fig. 27



GM 50-1020

PARMLY
Fig. 32



GM 50-1021

PARMLY
Fig. 32 A

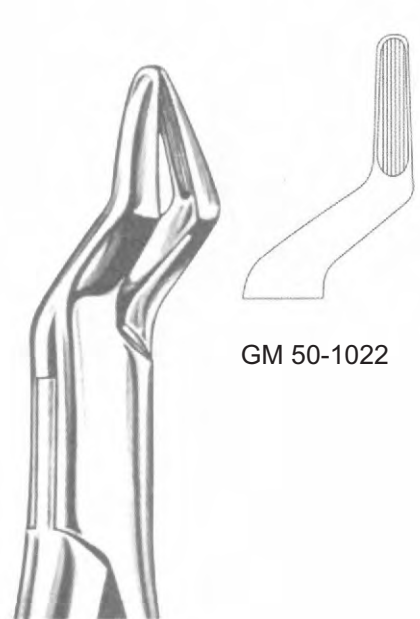

GM 50-1022

Fig. 35





GM 50-1023



GM 50-1024

Fig. 53 L

Fig. 53 R





Fig. 62



GM 50-1025



Fig. 65



GM 50-1026



TOMES
Fig. 69



GM 50-1027



THOMAS
Fig. 85



GM 50-1028



THOMAS
Fig. 85 A



GM 50-1029





CRYER Fig. 151

GM 50-1044



CRYER Fig. 151 A

GM 50-1045



Fig. 151 X

GM 50-1046



CRYER Fig. 151 AB

GM 50-1047



Fig. 151 AS

GM 50-1048



CRYER Fig. 151 S

GM 50-1049





GM 50-1035

Fig. 103

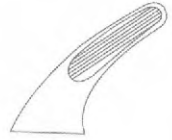

GM 50-1036

Fig. 10 H



GM 50-1037

Fig. 10 S



GM 50-1038

CRYER
Fig. 1GM 50



GM 50-1039

CRYER
Fig. 1GM 50 A



GM 50-1040

Fig. 1GM 50 X

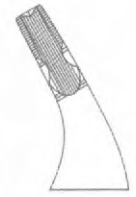



GM 50-1041

Fig. 1GM 50 AB



GM 50-1042

Fig. 1GM 50 AS



GM 50-1043

CRYER
 Fig. 1GM 50 S



CRYER Fig. 151

GM 50-1044



CRYER Fig. 151 A

GM 50-1045



Fig. 151 X

GM 50-1046

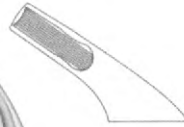

CRYER Fig. 151 AB

GM 50-1047



Fig. 151 AS

GM 50-1048



CRYER Fig. 151 S

GM 50-1049







Fig.201



GM 50-10GM 50



Fig.203

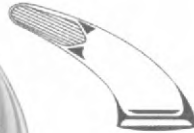

GM 50-1051



Fig.217



GM 50-1052



Fig.210 H



GM 50-1053



Fig.210 S



GM 50-1054

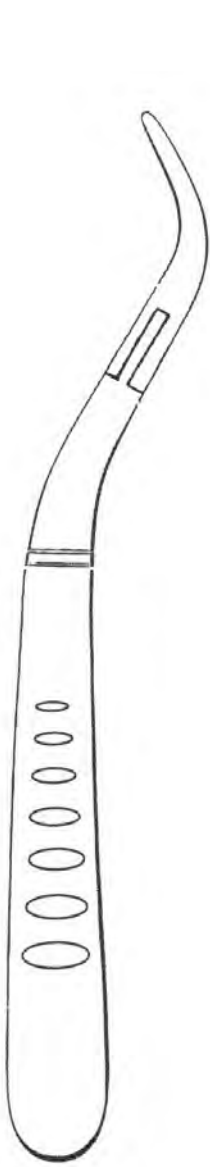

Fig.222



GM 50-1055





GM 50-1059

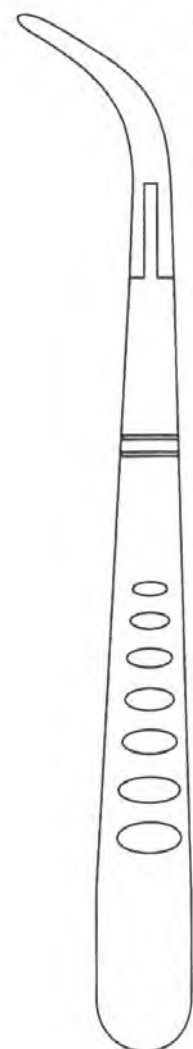

GM 50-1060

Fig.300

Fig.301



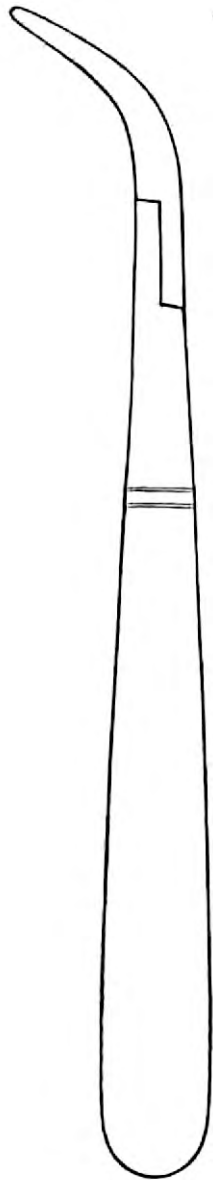

GM 50-1061
WITZEL
Fig.GM 501

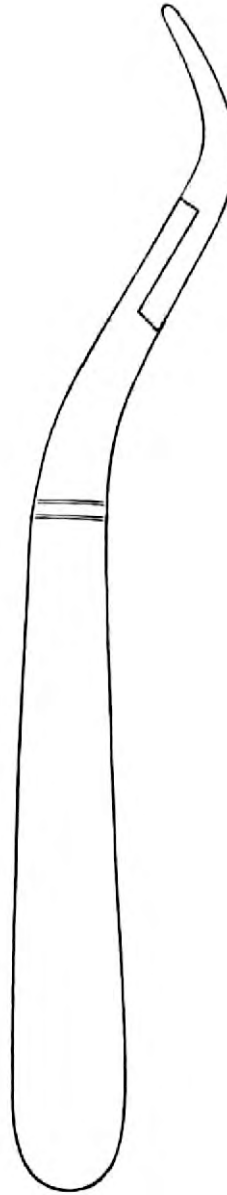

GM 50-1062
WITZEL
Fig.GM 502





GM 50-1063

Fig. 17 SK



GM 50-1064

Fig. 23 SK



GM 50-1065

Fig. 1GM 50 Sk



GM 50-1066

Fig. 151 Sk



51

- EN** Extracting forceps, English pattern
- DE** Zahnzangen, Englische Form
- ES** Daviers, forme anglaise

Page 16 to 39

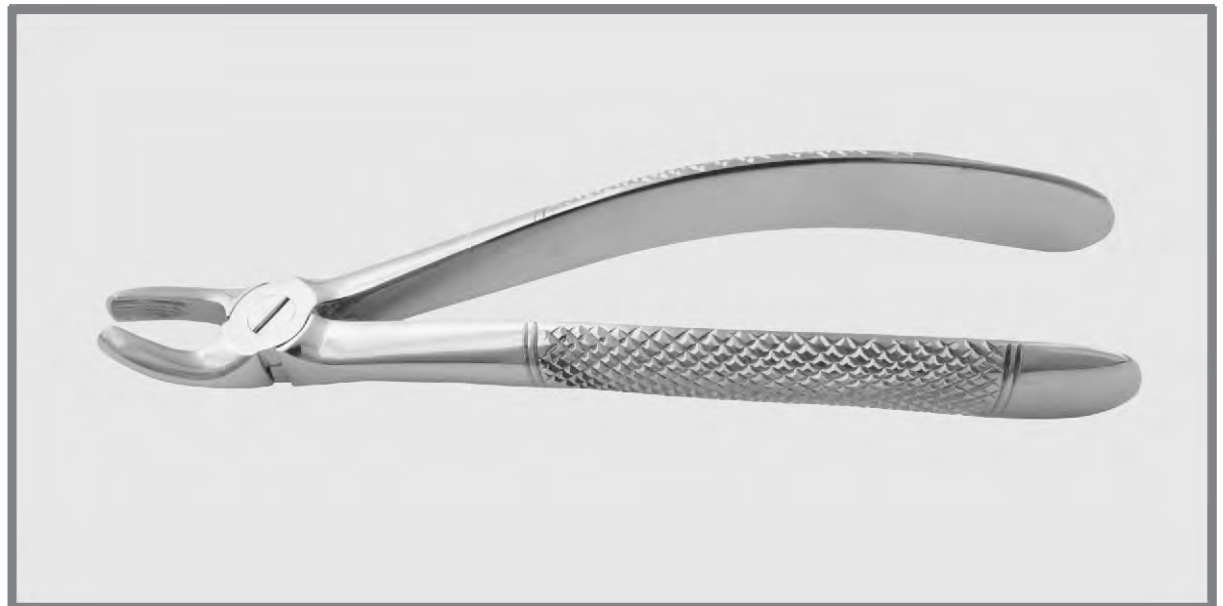



Fig. 1

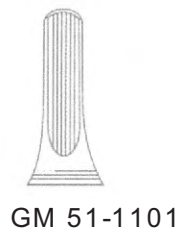

Fig. 2



Fig. 3



Fig. 4



Fig. 7





GM 51-1106

Fig. 8



Fig. 13



GM 51-1107



Fig. 17



GM 51-1108



Fig. 18

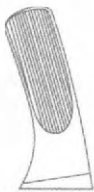

GM 51-1109



Fig. 18 A

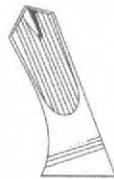

GM 51-1110



Fig. 19



GM 51-1111





Fig. 20



GM 51-1112



Fig. 21

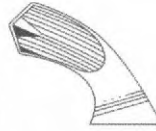

GM 51-1113



Fig. 22



GM 51-1114



Fig. 23



GM 51-1115



Fig. 24



GM 51-1116



GM 51-1117

Fig. 29

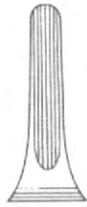

GM 51-1118

Fig. 29 N



GM 51-1119

Fig. 30



Fig. 31

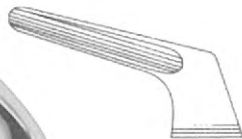

GM 51-1120



Fig. 32

GM 51-1121





Fig. 33

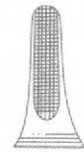

GM 51-1122



Fig. 33 A

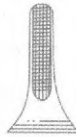

GM 51-1123



Fig. 33 C



GM 51-1124



Fig. 33 M



GM 51-1125



Fig. 33 W



GM 51-1126



GM 51-1127

Fig. 34



GM 51-1128

Fig. 35



GM 51-1129

Fig. 36





Fig. 41

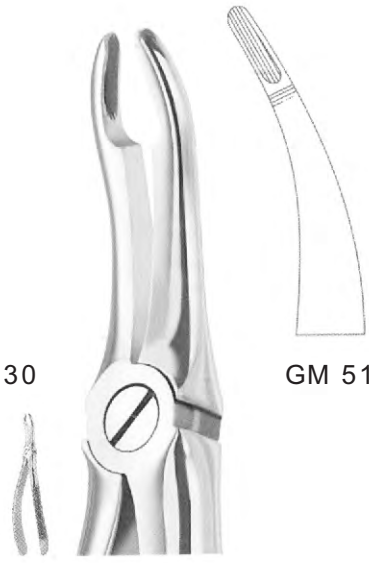
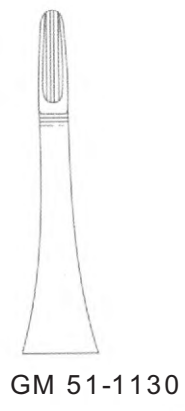

Fig. 44



Fig. 44 F

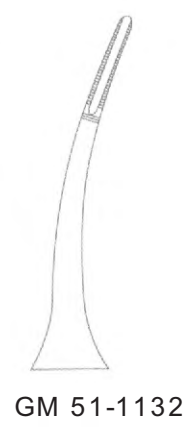

Fig. 45

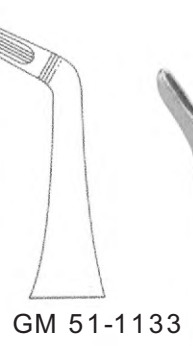

Fig. 45 F

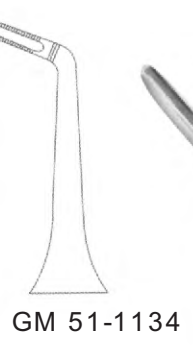
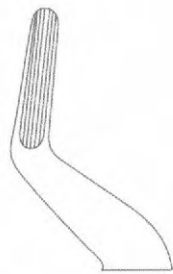

Fig. 46 L





Fig. GM 51



GM 51-1136



Fig. GM 51 A



GM 51-1137



Fig. GM 51 C

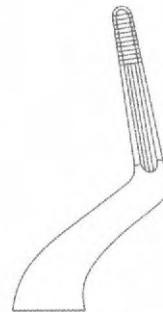

GM 51-1138



Fig. GM 51 L

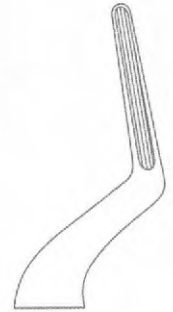

GM 51-1139





Fig. GM 51 M

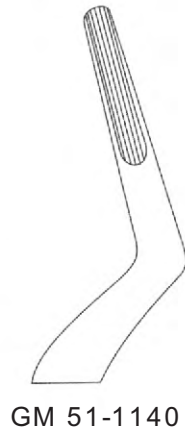

GM 51-1140



Fig. 52

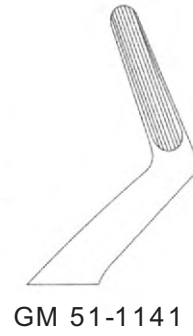

GM 51-1141



Fig. 52 A

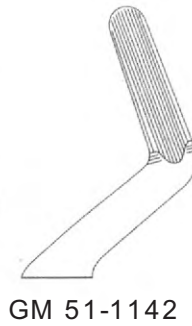

GM 51-1142



Fig. 53

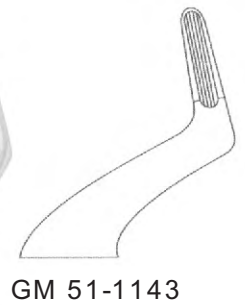

GM 51-1143



Fig. 55



GM 51-1144

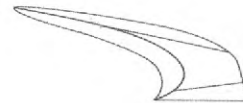
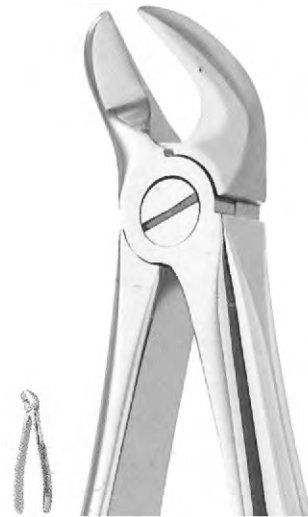

GM 51-1145

Fig. 56

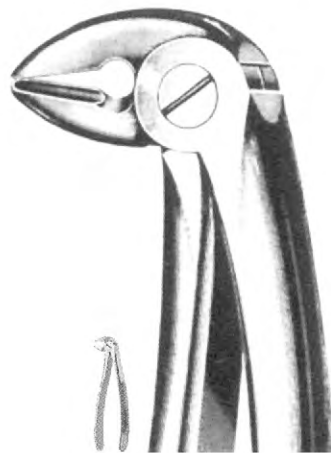

GM 51-1146

BUSCH
Fig. 59

breit
broad

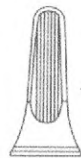

GM 51-1147

BUSCH
Fig. 60

schmal
narrow



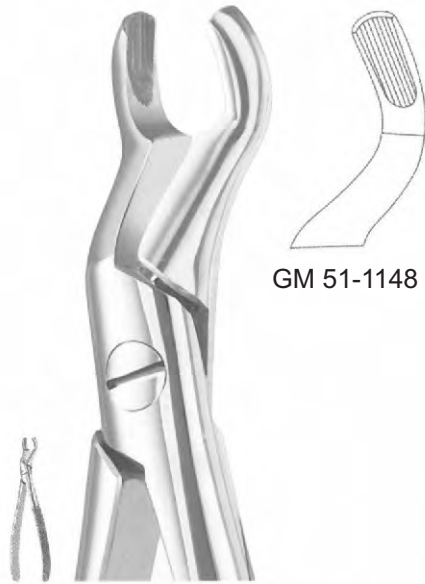

GM 51-1148

Fig. 67

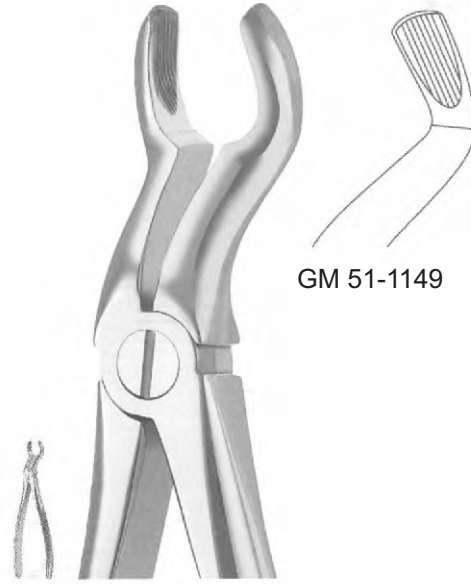

GM 51-1149

Fig. 67 A

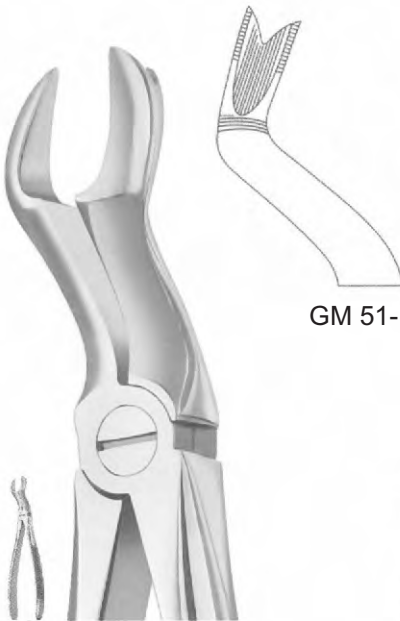

GM 51-1150

Fig. 67 LX

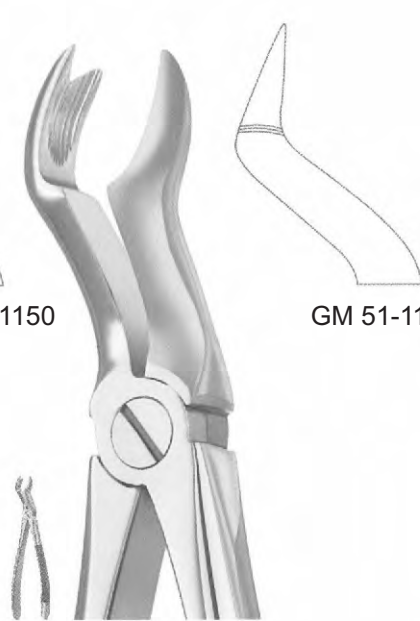

GM 51-1151

Fig. 67 RX

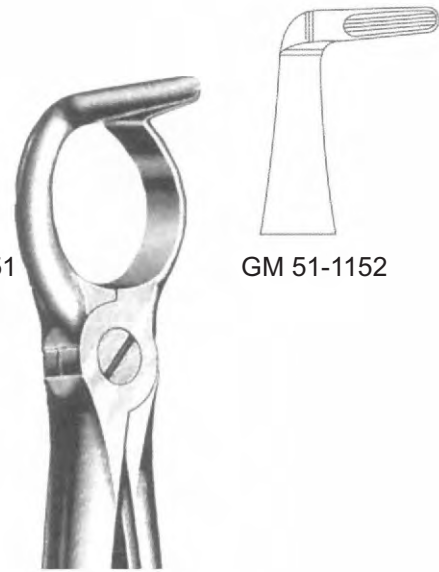

GM 51-1152

RYDING
Fig. 68



Fig. 73



GM 51-1153



Fig. 74

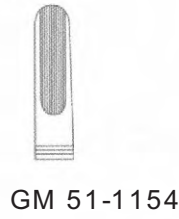

GM 51-1154



Fig. 74 M



GM 51-1155



Fig. 74N

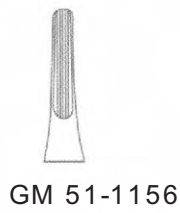

GM 51-1156



Fig. 75



GM 51-1157





GM 51-1158

LAWRENCE-READ
Fig. 76



GM 51-1159

LAWRENCE-READ
Fig. 76 N

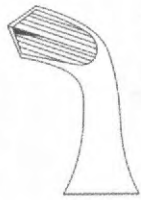

GM 51-1160

Fig. 79

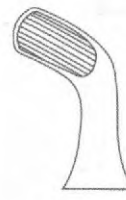
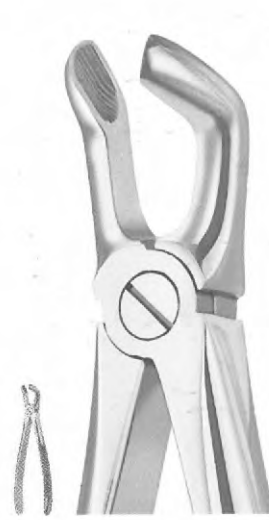

GM 51-1161

Fig. 79 A



GM 51-1162

Fig. 86 A

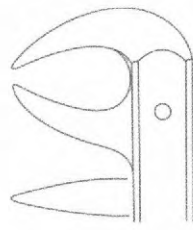

GM 51-1163

Fig. 86 B

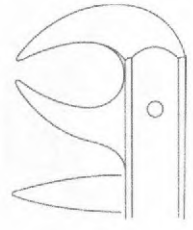

GM 51-1164

Fig. 86 C



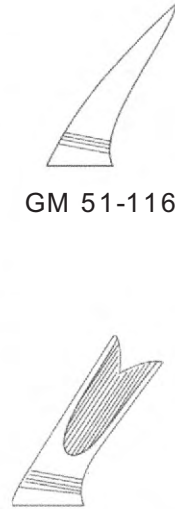

Fig. 87

GM 51-1165



Fig. 89



GM 51-1166



Fig. 90



GM 51-1167



Fig. 94



GM 51-1168



Fig. 95

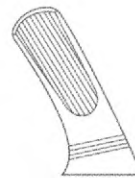

GM 51-1169



WOOD
Fig. 99



GM 51-1170



GM 51-1171

Fig. 113



GM 51-1172

OGDEN FELSCH
Fig. 121



GM 51-1173

GUY
Fig. 136



GM 51-1174

GUY
Fig. 137



Fig. 160



GM 51-1175



Fig. 162

GM 51-1176





GM 51-1177
Fig. 233



GM 51-1178



GM 51-1179
Fig. 235



MEAD
Fig. MD 1

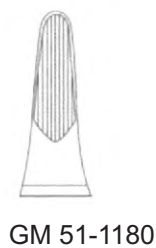

GM 51-1180



MEAD
Fig. MD 2



GM 51-1181



MEAD
Fig. MD 3



GM 51-1182



MEAD
Fig. MD 4



GM 51-1183





COHEN



GM 51-1184

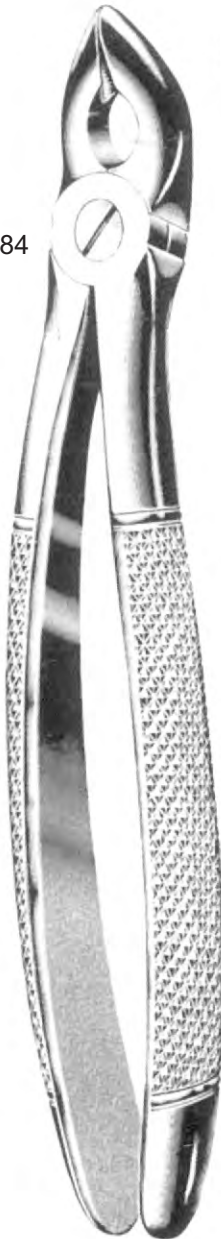

COHEN



GM 51-1185



STIKSA



GM 51-1186



STIKSA



GM 51-1187



Fig. 13 S



Fig. 22 S



Fig. 29 S



Fig. 30 S



Fig. 33 S



Fig. 37



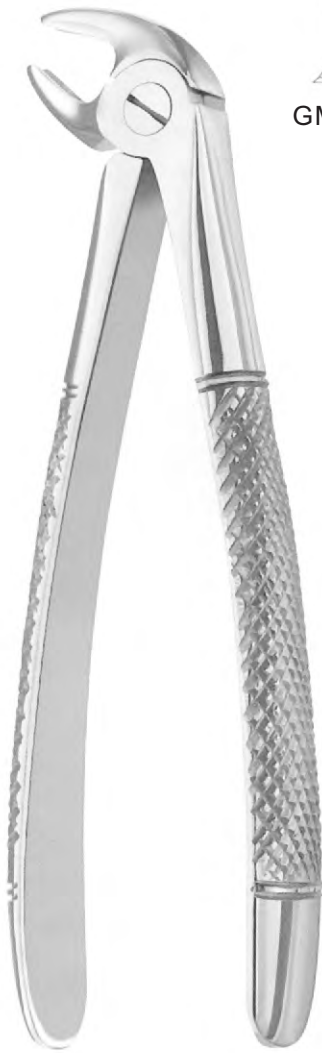

Fig. 38



GM 51-1194



Fig. 39



GM 51-1195



Fig. 39 A



GM 51-1196



Fig. 39 L



GM 51-1197



Fig. 39 R



GM 51-1198



Fig. 40

Fig. GM 51 S

GM 51-1201
 LAWRENCE-READ
 Fig. 76 S





KLEIN
Fig. 3



GM 51-1202



Fig. 5



GM 51-1203



Fig. 6



GM 51-1204



Fig. 7



GM 51-1205



KLEIN
Fig. 137



KLEIN
Fig. 139



KLEIN
Fig. GM 51 S



52

- EN** Root Elevators
- DE** Wurzelheber
- ES** Elevadores á racines

Page 40 to 54

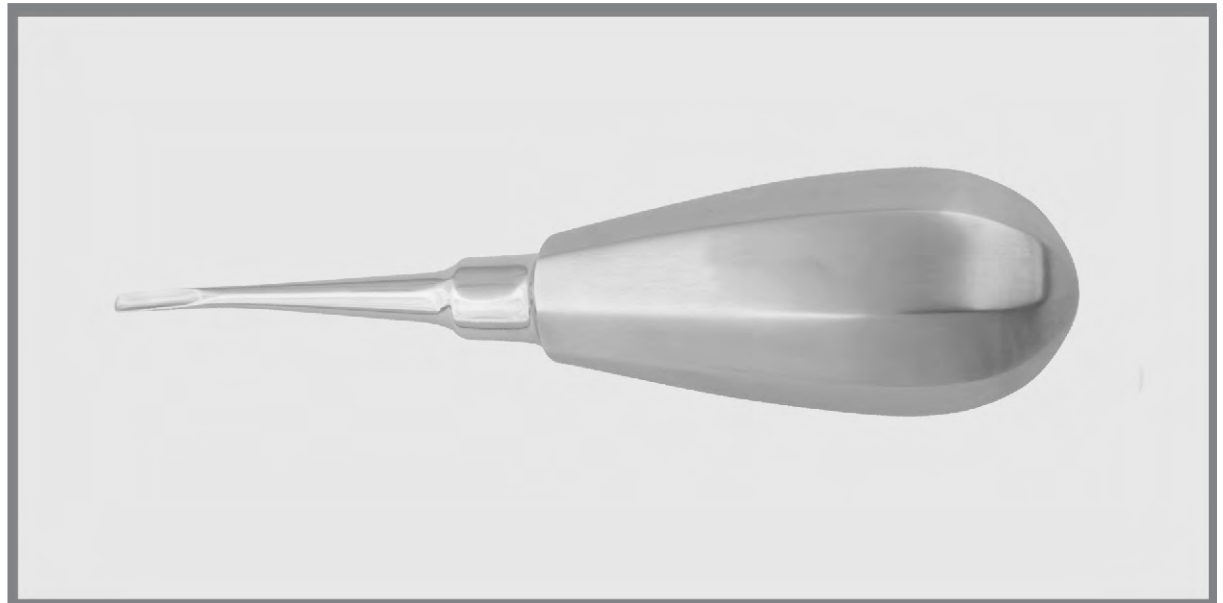

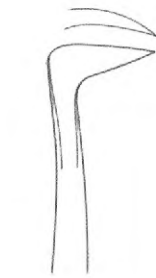

GM 52-1251
Fig. 1 L



GM 52-12GM 52
Fig. 1 R



SALDIN
GM 52-1253
Fig. 2



SELDIN
GM 52-1254
Fig. 3

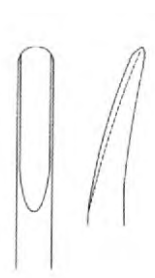

CRYER
GM 52-1255
Fig. 3 A



SELDIN
GM 52-1256
Fig. 4 L



SELDIN
GM 52-1257
Fig. 4 R



CRANE
(COGSWELL)
GM 52-1258
Fig. 6

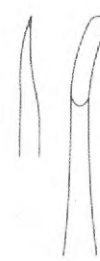

MILLER
GM 52-1259
Fig. 8

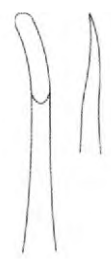

MILLER
GM 52-1260
Fig. 9



MILLER (Apexo)
GM 52-1261
Fig. 10



MILLER (Apexo)
GM 52-1262
Fig. 11

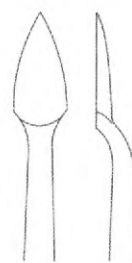

CRYER
GM 52-1263
Fig. 12



CRYER
 GM 52-1264
 Fig. 27



CRYER
 GM 52-1265
 Fig. 28



CRYER
 GM 52-1266
 Fig. 27 S



CRYER
 GM 52-1267
 Fig. 28 S



SELDIN
 GM 52-1268
 Fig. 34

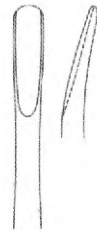

SELDIN
 GM 52-1269
 Fig. 34 S



CRYER
 GM 52-1270
 Fig. 39



CRYER
 GM 52-1271
 Fig. 40



FLOHR
 GM 52-1272
 Fig. 46



GM 52-1273
 Fig. 50



GM 52-1274
 Fig. 51





APICAL (Apexo)
 GM 52-1275
 Fig. 301

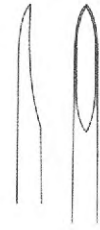

GM 52-1276
 Fig. 304

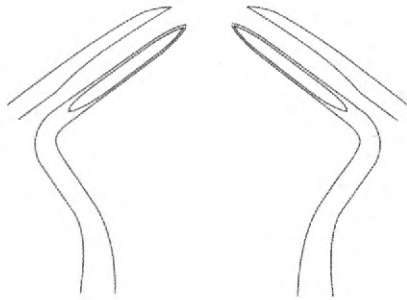

GM 52-1277
 Fig. 302

FLOHR
 GM 52-1278
 Fig. 303



COLEMAN

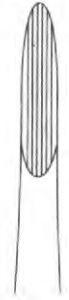

GM 52-1279
 Fig. 1

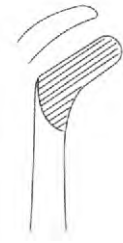

GM 52-1280
 Fig. 2 L

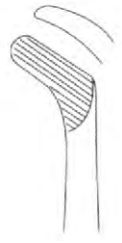

GM 52-1281
 Fig. 3 R



WARWICK JAMES
 GM 52-1282
 16 cm/6 1/4"



GM 52-1283
 Fig. 2 L



GM 52-1284
 Fig. 3 L



KOPP



GM 52-1285
 Fig. 1



GM 52-1286
 Fig. 2



GM 52-1287
 Fig. 3



GM 52-1288
 Fig. 4





KOPP



GM 52-1289
Fig. 1



GM 52-1290
Fig. 2



GM 52-1293
Fig. 1



GM 52-1291
Fig. 3



GM 52-1292
Fig. 4



GM 52-1294
Fig. 2



GM 52-1295
Fig. 3



FLOHR



FRIEDMAN
GM 52-1296
Fig 1

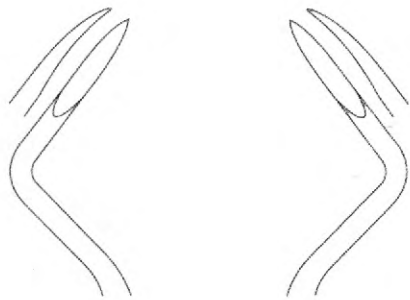

GM 52-1297 GM 52-1298
Fig. 2 L Fig. 3 R



HYLIN
GM 52-1299
Fig. 1

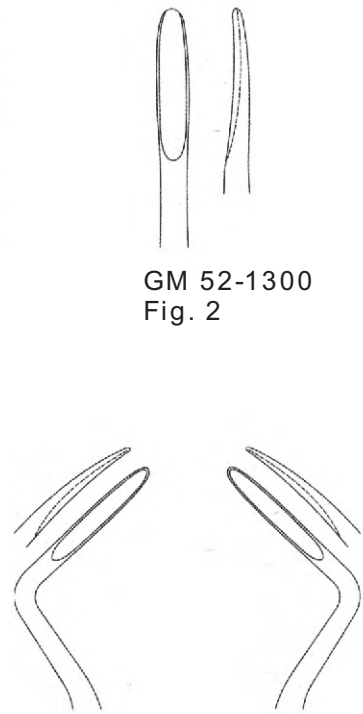

GM 52-1301 GM 52-1302
Fig. 3 L Fig. 4 R

GM 52-1300
Fig. 2





2 mm



GM 52-1303
Fig.0

3 mm



BEIN
GM 52-1304
Fig. 1

4 mm



GM 52-1305
Fig. 2

2 mm

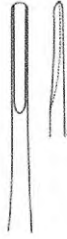

GM 52-1306
Fig. 0

3 mm



BEIN
GM 52-1307
Fig. 1

4 mm



GM 52-1308
Fig. 2

2 mm



GM 52-1309
Fig. 0

3 mm



BEIN
GM 52-1310
Fig. 1

4 mm



GM 52-1311
Fig. 2

2 mm



GM 52-1312
Fig. 0 A

3 mm



BEIN
GM 52-1313
Fig. 1 A

4 mm



GM 52-1314
Fig.2 A

2 mm



GM 52-1315
Fig.0 A

3 mm



BEIN
GM 52-1316
Fig. 1 A

4 mm



GM 52-1317
Fig. 2 A



COUPLAND

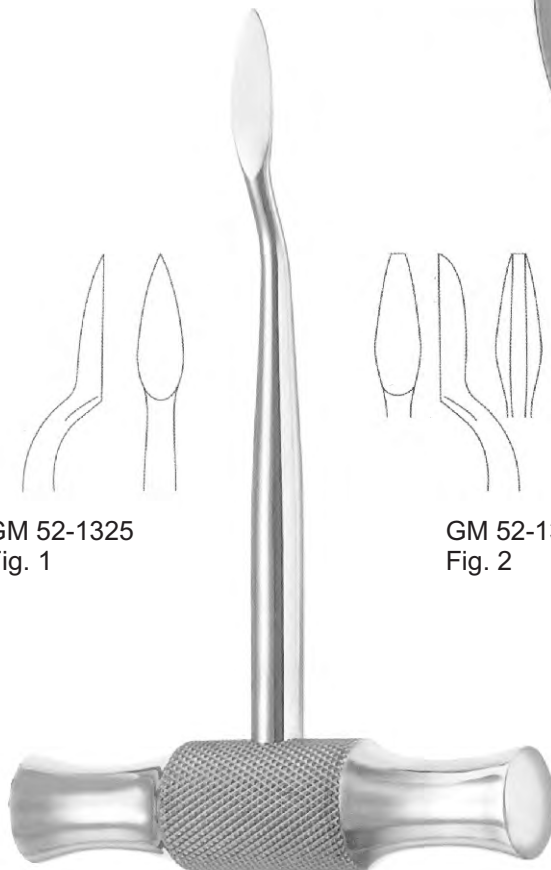
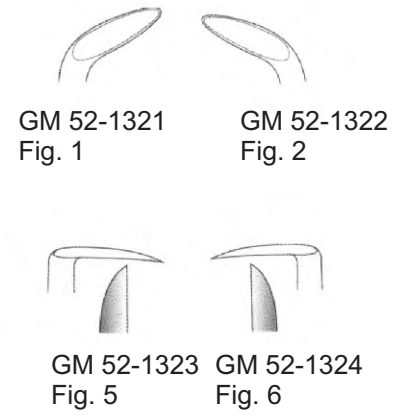
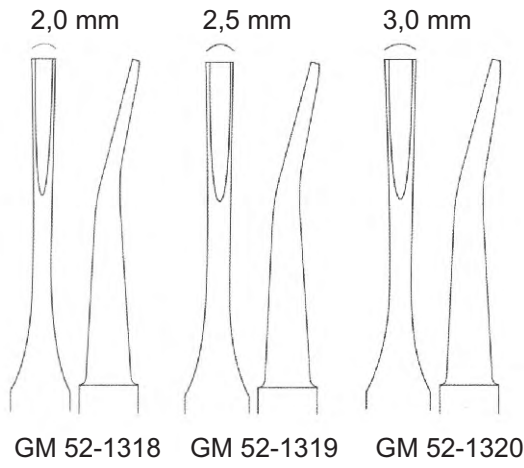

LECLUSE



LOOS





BARRY
 11 cm/4 F '



GM 52-1327
 Fig. 320 L



GM 52-1328
 Fig. 321 R



GM 52-1329
 Fig. 322



GM 52-1330
 Fig. 323



GM 52-1331
 Fig. 370



GM 52-1332
 Fig.371



GM 52-1333
Fig. 1 L



GM 52-1334
Fig. 1 R



GM 52-1335
Fig. 11 L



GM 52-1336
Fig. 11 R



GM 52-1337
Fig. 12 L



GM 52-1338
Fig. 12 R



WINTER
11 cm/4 F



GM 52-1339
Fig. 13 L



GM 52-1340
Fig. 13 R



GM 52-1341
Fig. 14 L



GM 52-1342
Fig. 14 R





CHOMPRET



GM 52-1343
Fig. 1

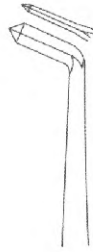

GM 52-1344
Fig. 2



GM 52-1345
Fig. 3



GM 52-1346
Fig. 4



BERNARD



GM 52-1347
Fig. 0

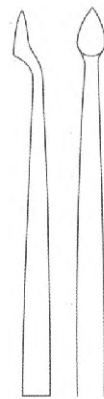

GM 52-1348
Fig. 1

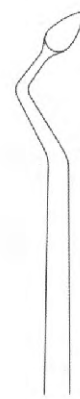

GM 52-1349
Fig. 2

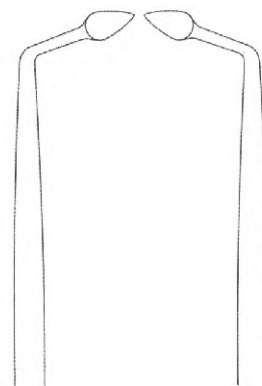

GM 52-1350
Fig. 6

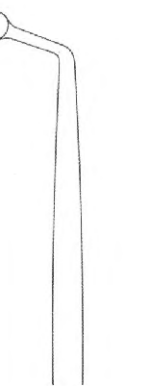

GM 52-1351
Fig. 7



GM 52-13GM 52
Fig. 11



BERNARD
Handle # A

BERNARD
Handle # B



GM 52-1353
Fig. 1



GM 52-1354
Fig. 2



GM 52-1355
Fig. 3



GM 52-1356
Fig. 4

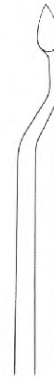

GM 52-1357
Fig. 5



GM 52-1358
Fig. 10



GM 52-1359
Fig. 8

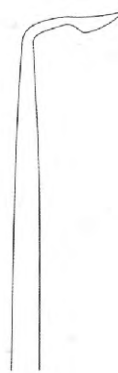

GM 52-1360
Fig. 9

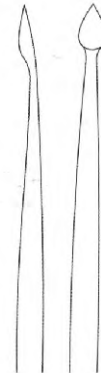

GM 52-1361
Fig. 11



GM 52-1362
Fig. 7

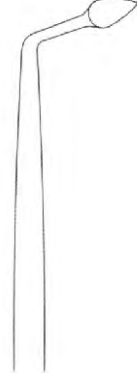

GM 52-1363
Fig. 6





HEIDBRINK

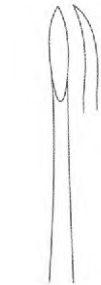

GM 52-1366
Fig. 1



GM 52-1367
Fig. 2



GM 52-1368
Fig. 3



WEST (Apical)



GM 52-1369
Fig. 1

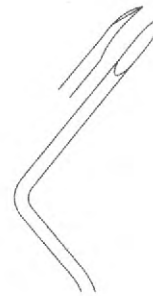

GM 52-1370
Fig. 2 R

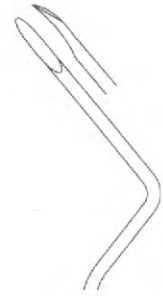

GM 52-1371
Fig. 3 L



RATZOW

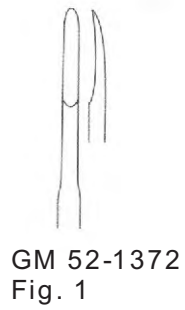

GM 52-1372
Fig. 1



GM 52-1373
Fig. 2



GM 52-1374
Fig. 3



HEIDBRINK

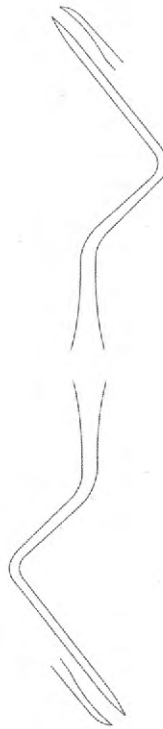

GM 52-1375
Fig. 1

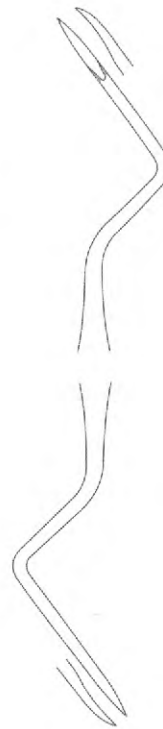

GM 52-1376
Fig. 2

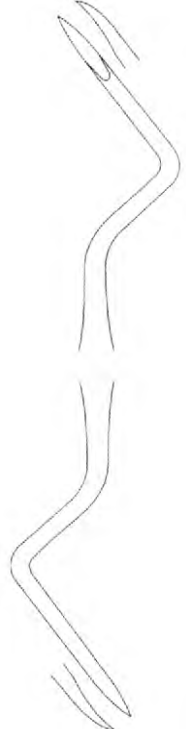

GM 52-1377
Fig. 23





VIGNAL



GM 52-1378
Fig. 54



GM 52-1379
Fig. 55

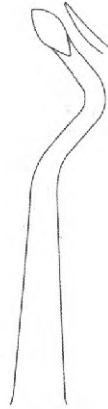

GM 52-1380
Fig.56



GM 52-1381
Fig.57



GM 52-1382
Fig. 69

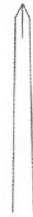

BARRY
21.5 cm/8 3/4"

4 mm



GM 52-1383

5 mm



GM 52-1384

6 mm



GM 52-1385

53

- EN** Bone Files
- DE** Bone-Dateien
- ES** Archivos de huesos

Page 55 to 56

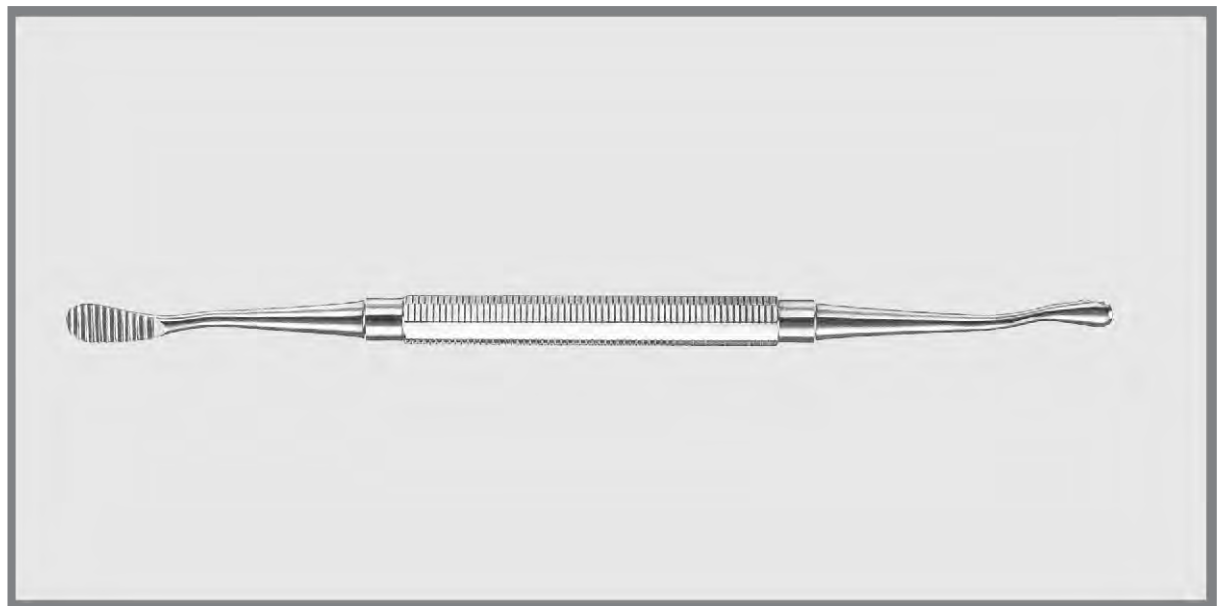

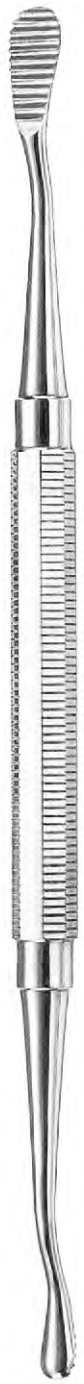

downwards cutting

MILLER-COLBURN
18 cm/7"

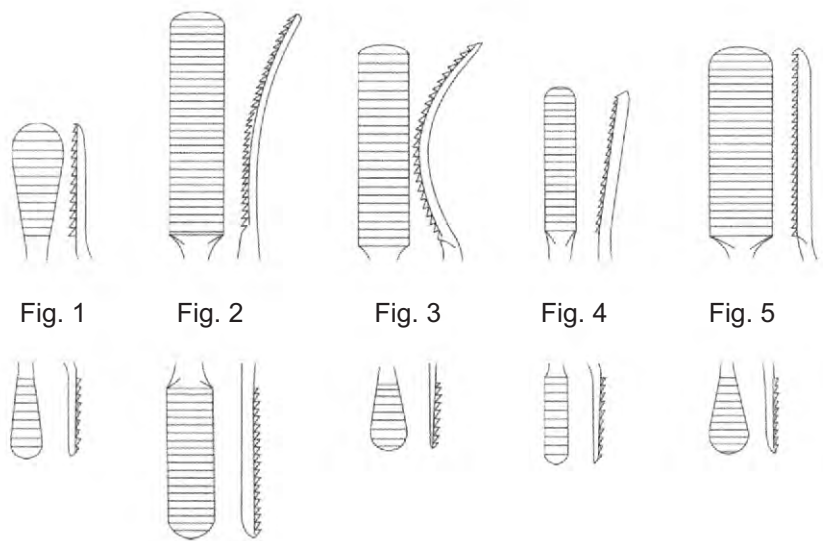

Fig. 1

Fig. 2

Fig. 3

Fig. 4

Fig. 5

GM 53-1401

GM 53-1402

GM 53-1403

GM 53-1404

GM 53-1405

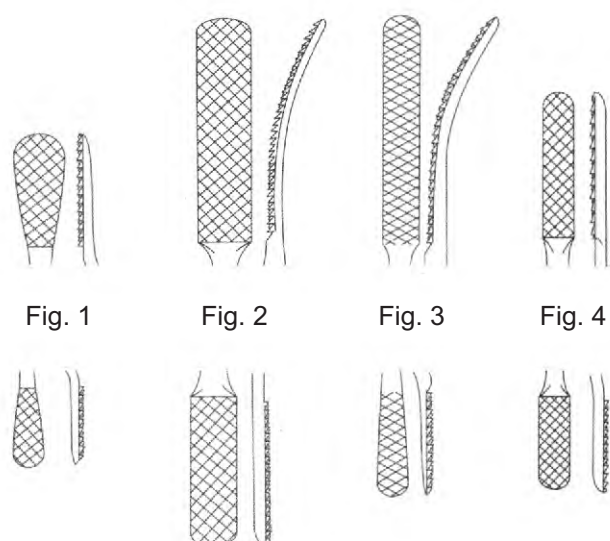

Fig. 1

Fig. 2

Fig. 3

Fig. 4

GM 53-1406

GM 53-1407

GM 53-1408

GM 53-1409

cross cut



MILLER-COLBURN
18 cm/7"



SELDIN
 GM 53-1410
 18 cm/7'
 Fig. 11



SELDIN
 GM 53-1411
 18 cm/7'
 Fig. 12



54

- EN** Dental Probes
- DE** Zahnsonden
- ES** Sondas dentales

Page 57 to 58

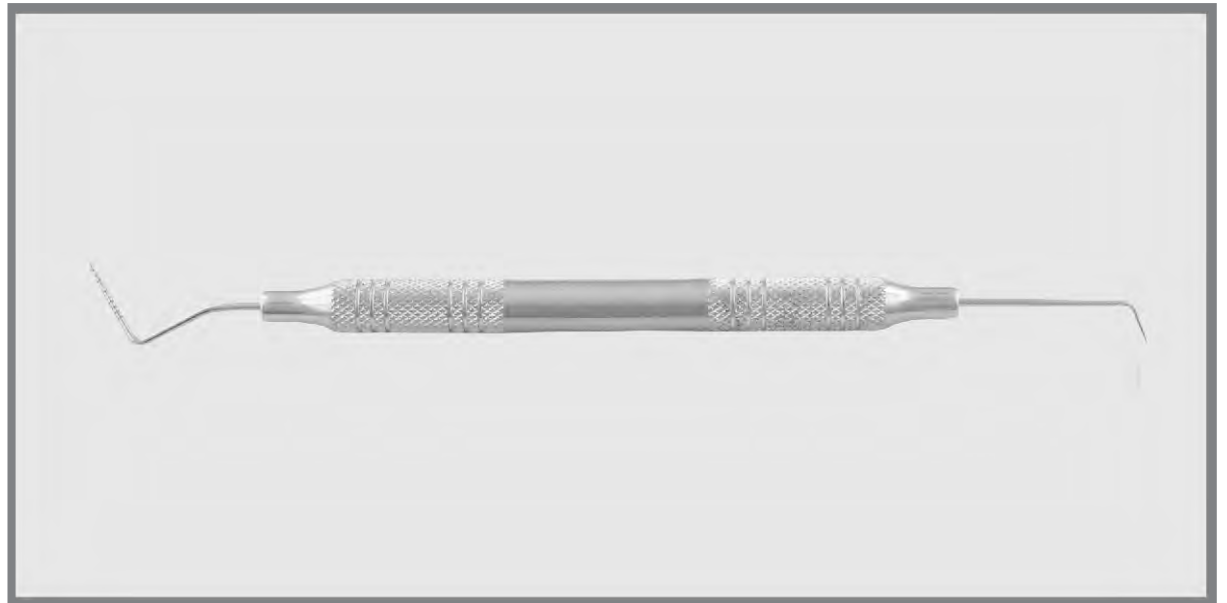



3-6-8-11



Fig. 8
GM 54-1451

1-2-3-5-7-8-9-10



Fig. 10
GM 54-1452

3-6-8-11



Fig. 11
GM 54-1453

1-2-3-5-7-8-9-10



Fig. W
GM 54-1454
Williams

3-6-9-12



Mercury
GM 54-1455

1-2-3-5-7-8-9-10

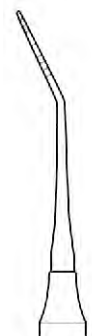

Merrit A
GM 54-1456

1-2-3-5-7-8-9-10

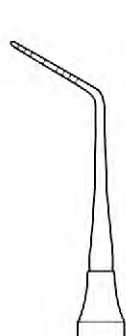

Merrit E
GM 54-1457

1-2-3-5-7-8-9-10

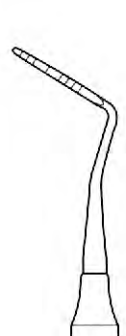

Goldman-Fox
GM 54-1458

3-6-8



Michigan
GM 54-1459

3-6-9-12

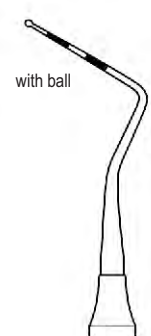

Fig. CPNG 12S
GM 54-1460

3.5-5.5-8.5-11.5



Fig. CPG 11.5 WHO
GM 54-1461

3-6-9-12



Fig. CPG 12
GM 54-1462

1-2-3-4-5-6-7-8-9-10-11-12-13-14-15



Fig. CP 15 UNC
GM 54-1463

2-4-6-8-10-12

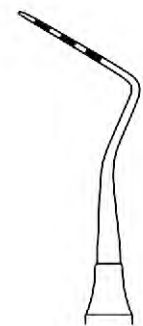

Fig. CPNG 22
GM 54-1464

1-2-3-5-7-8-9-10

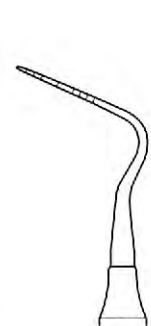

Fig. 26G
GM 54-1465

1-2-3-5-7-8-9-10
 FLAT



Goldman-Fox
 Williams
 GM 54-1466

3-6-9-12



Fig. UT 3/4
 Cattoni
 GM 54-1467



12-9-6-3

1-2-3-5-7-8-9-10
 FLAT

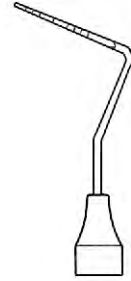
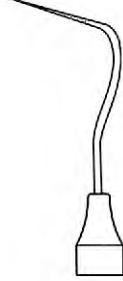

Fig. 3N
 Nabers
 GM 54-1468



10-9-8-7-5-3-2-1

1-2-3-5-7-8-9-10



Williams DE
 Offset
 GM 54-1469



10-9-8-7-5-3-2-1

3-6-9-12

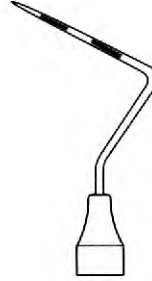
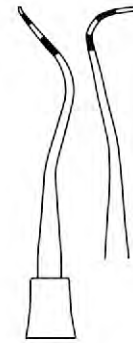

Fig. CP 12/Thin
 Williams
 GM 54-1470



10-9-8-7-5-3-2-1



Nabers Furcation
 probes graduated
 working end
 GM 54-1471



55

- EN** Enamel Instruments
- DE** Emaille-Instrumente
- ES** Instrumentos de esmalte

Page 59 to 62

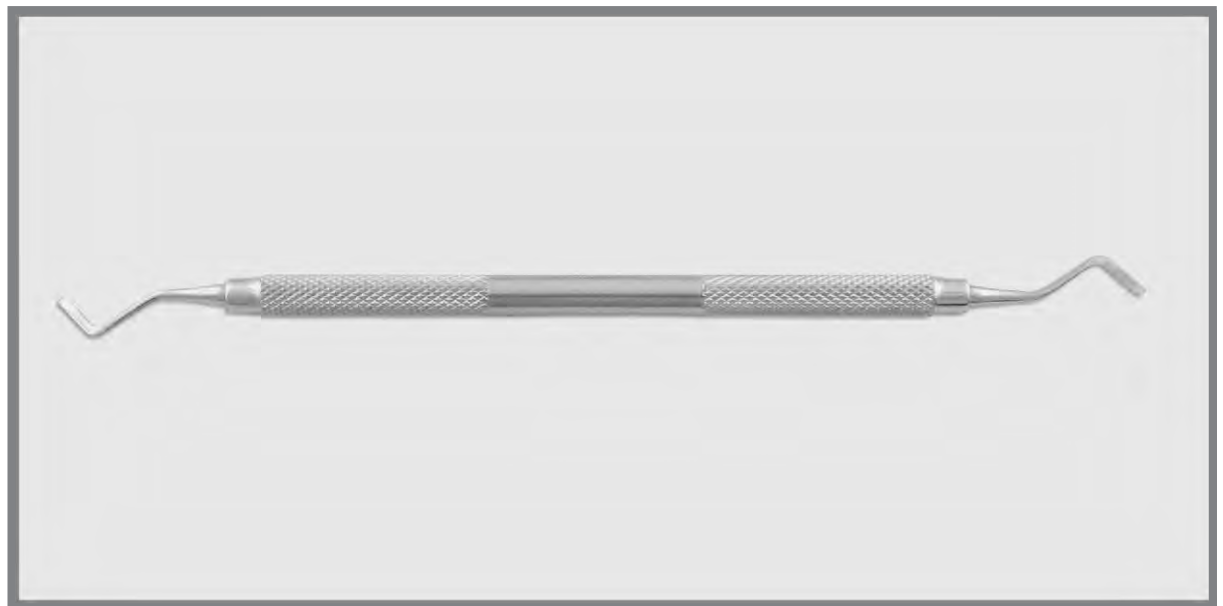

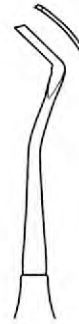

GM 55-1501
 Fig. 1
 Black

GM 55-1502
 Fig. 2
 Black

GM 55-1503
 Fig. 26
 Black

GM 55-1504
 Fig. 27
 Black

GM 55-1505
 Fig. 28
 Black

GM 55-1506
 Fig. 29
 Black



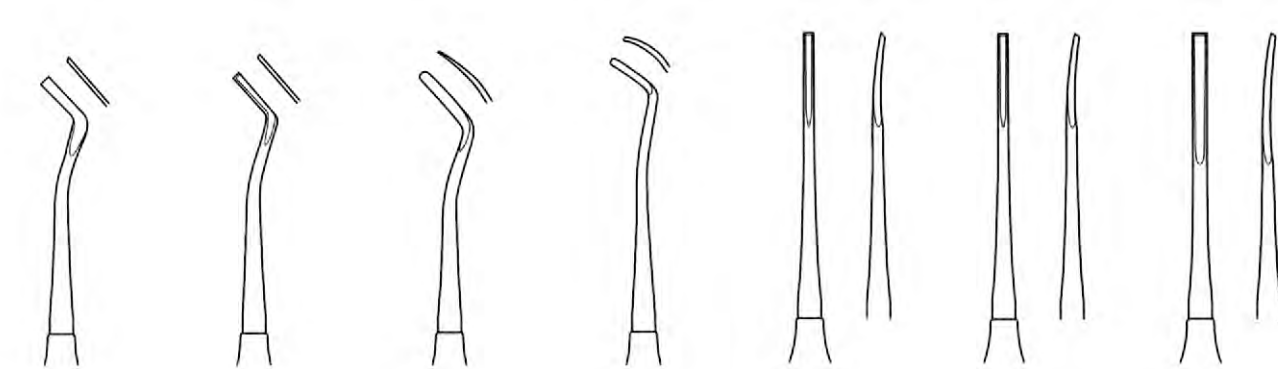

GM 55-1507
 Fig. 51/52
 Black

GM 55-1508
 Fig. 53/54
 Black

GM 55-1509
 Fig. 63/64
 Black

GM 55-1510
 Fig. 65/66
 Black

GM 55-1511
 Fig. 1/2
 Wedelstaedt

GM 55-1512
 Fig. 3/4
 Wedelstaedt

GM 55-1513
 Fig. 5/6
 Wedelstaedt

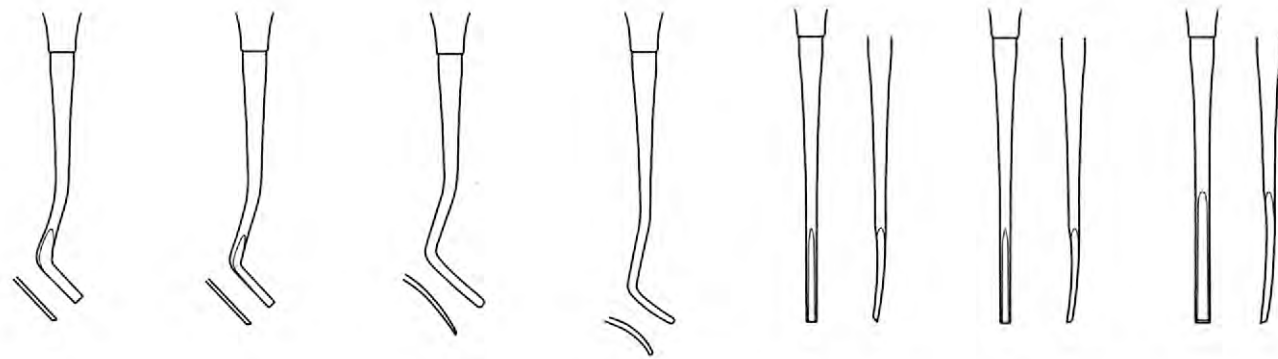

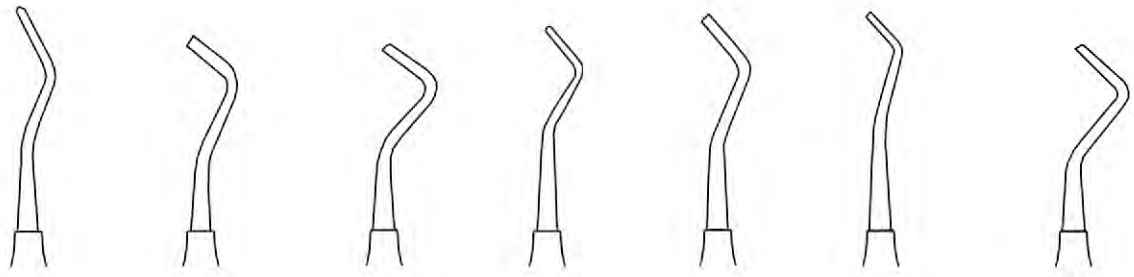

GM 55-1514 Fig. 8/9H GM 55-1515 Fig. 13/14 GM 55-1516 Fig. 15/16 GM 55-1517 Fig. 17/18 GM 55-1518 Fig. 51/52 GM 55-1519 Fig. 53/54 GM 55-1520 Fig. 14/14 Off Angle

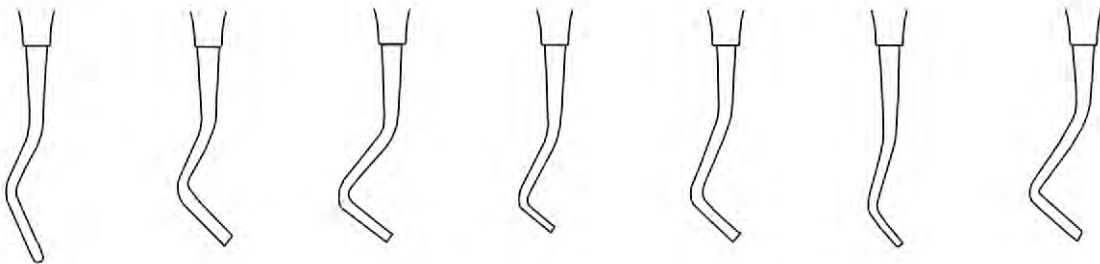

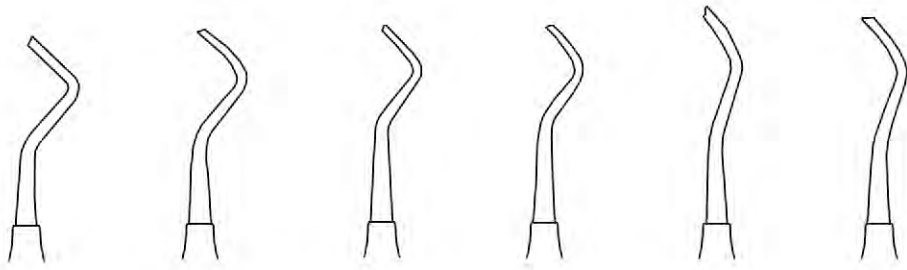

GM 55-1521	GM 55-1522	GM 55-1523	GM 55-1524	GM 55-1525	GM 55-1526
Fig. 26	Fig. 27	Fig. 28	Fig. 29	Fig. 77/78	Mesial
Distal	Mesial	Distal	Mesial	Distal	54-1142-00

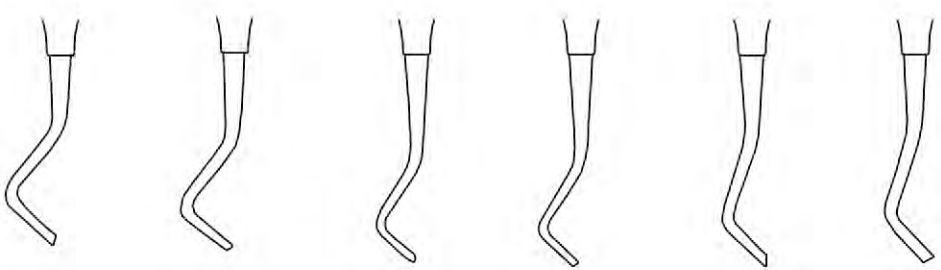

56

- EN** Dental Scalers
- DE** Zahnsteinentferner
- ES** Escaladores dentales

Page 63 to 78

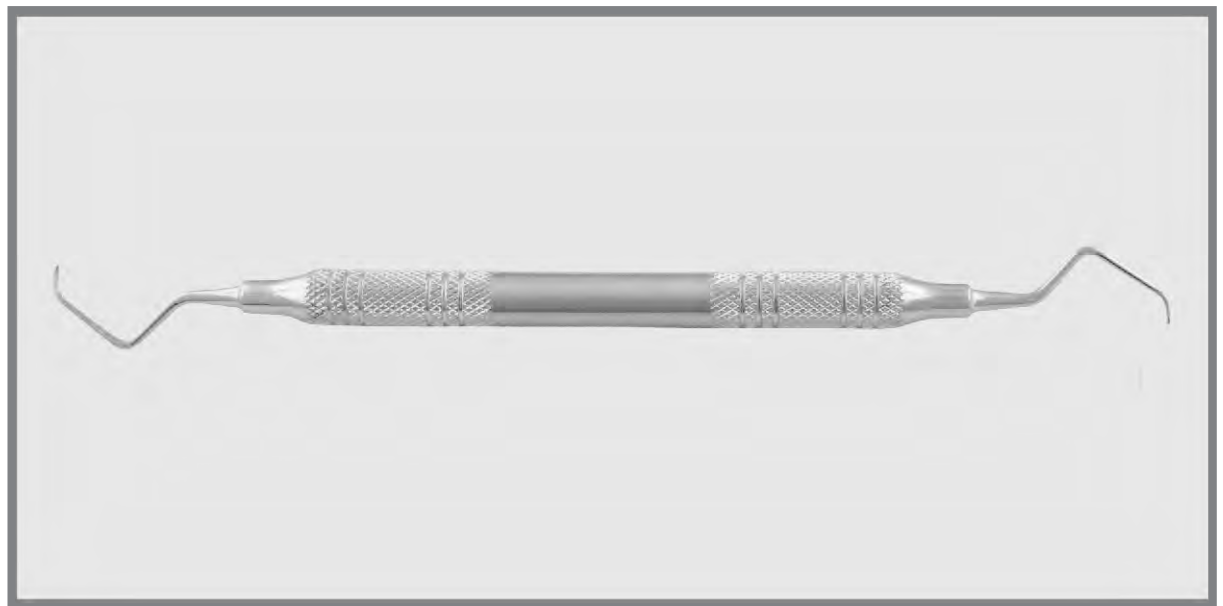



Fig. 3
700-140

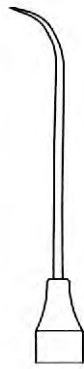

Fig. 3A
GM 56-1551



Fig. 5
GM 56-1552

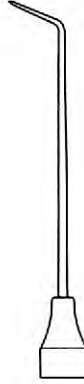

Fig. 6
GM 56-1553
6.5 mm

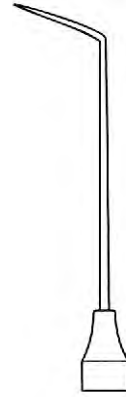

Fig. 6A
GM 56-1554
12 mm

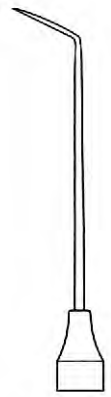

Fig. 6L
GM 56-1555
9 mm

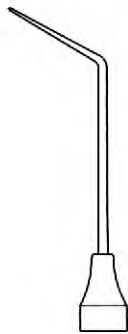

Fig. 6XL
GM 56-15GM 56
12.5 mm



Fig. 8
GM 56-1557



Fig. 8A
GM 56-1558

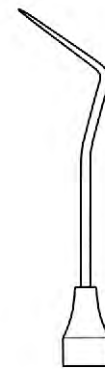

Fig. 9
GM 56-1559



Fig. 10
GM 56-1GM 560

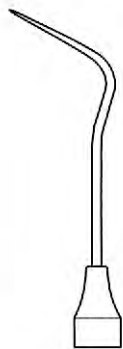

Fig. 12
GM 56-1GM 561



Fig. 17
GM 56-1GM 562



Fig. 17A
GM 56-1GM 563

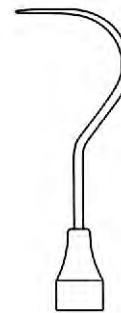

Fig. 23
GM 56-1GM 564
Shepherd's Hook

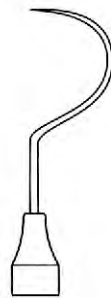

Fig. 54
GM 56-1GM 565



Fig. UT 1/2
GM 56-1GM 566



Fig. UT 2/2
GM 56-1GM 567

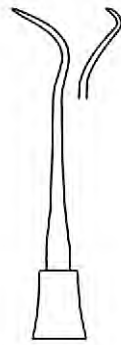

Fig. 3CH/3CH
GM 56-1GM 568

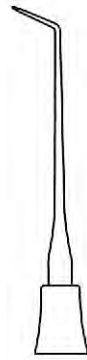

Fig. 6/3
GM 56-1GM 569

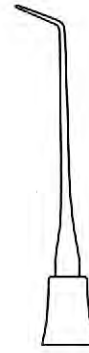

Fig. 16/3
GM 56-1570



Fig. 2
GM 56-1571

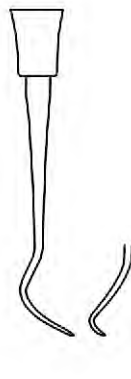
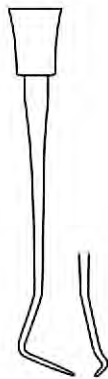



Fig. 23/17
GM 56-1572



Fig. 2A
GM 56-1573



Fig. 3
GM 56-1574



Fig. 1N
GM 56-1575
Nabers

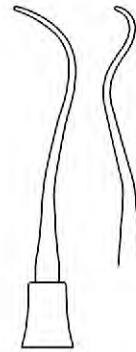

Fig. 2N
GM 56-1576
Nabers

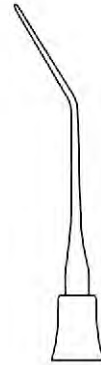

Fig. 5/6
GM 56-1577

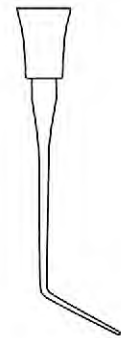
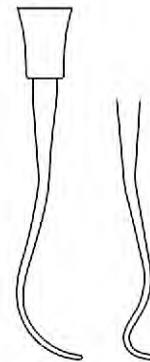
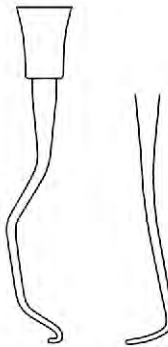
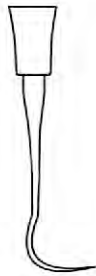



Fig. 16/23
GM 56-1578



Fig. 6/23
GM 56-1579



Fig. 6/17
GM 56-1580

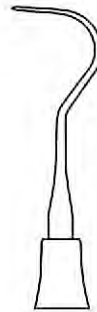
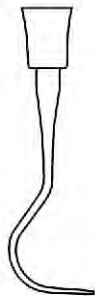

Fig. 23/17A
GM 56-1581



Fig. 3/23
GM 56-1582





GM 56-1583
Fig. 1/2



GM 56-1584
Fig. 3/4



GM 56-1585
Fig. 5/6



GM 56-1586
Fig. 7/8





GM 56-1587
Fig. 9/10



GM 56-1588
Fig. 11/12



GM 56-1589
Fig. 13/14



GM 56-1590
Fig. 15/16

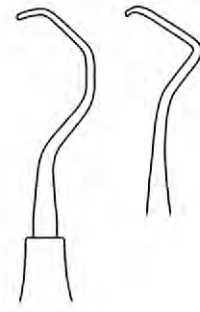

GM 56-1591
Fig. 17/18

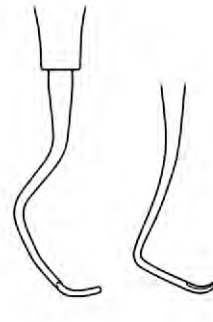



Langer
 GM 56-1592
 Fig. 1/2

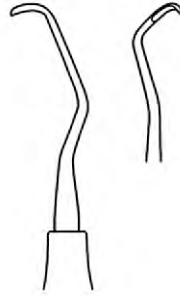

Langer
 GM 56-1593
 Fig. 3/4



Langer
 GM 56-1594
 Fig. 5/6



Langer
 GM 56-1595
 Fig. 17/18



Universal curettes are designed for easy access on all tooth surfaces (thus the name "universal").

The blade of a universal curette has a rounded back, and two cutting edges for scaling, making it an efficient design for scaling the entire mouth.

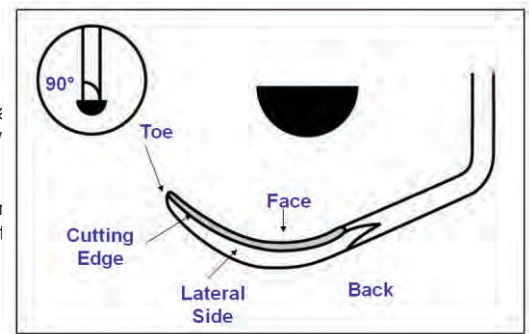



Columbia
 GM 56-1596
 Fig. 13/14



Columbia
 GM 56-1597
 Fig. 2R/2L



Columbia
 GM 56-1598
 Fig. 4R/4L



GM 56-1599
 Fig. Gx4



Barnhart
 GM 56-1600
 Fig. 1/2



Barnhart
 GM 56-1601
 Fig. 5/6





GM 56-1602
Fig. Me1



GM 56-1603
Rule [23-24]
Fig. 3/4



GM 56-1604
Fig. IU 13/14
Indiana University



GM 56-1605
Fig. IU 17/18
Indiana University



GM 56-1606
Fig. 7/8
Younger-Good



GM 56-1607
Fig. 1/2
Bunting



GM 56-1608
Fig. 5/6
Bunting





GM 56-1609
 Fig. 1
 Furcation curette



GM 56-1610
 Fig. 2
 Furcation curette



GM 56-1611
 Fig. 3
 Furcation curette

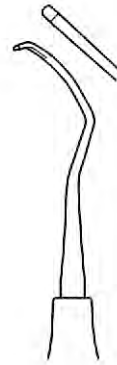

GM 56-1612
 Fig. 4
 Furcation curette



GM 56-1613
 Fig. 5
 Furcation curette



GM 56-1614
 Fig. 1/2
 Prichard



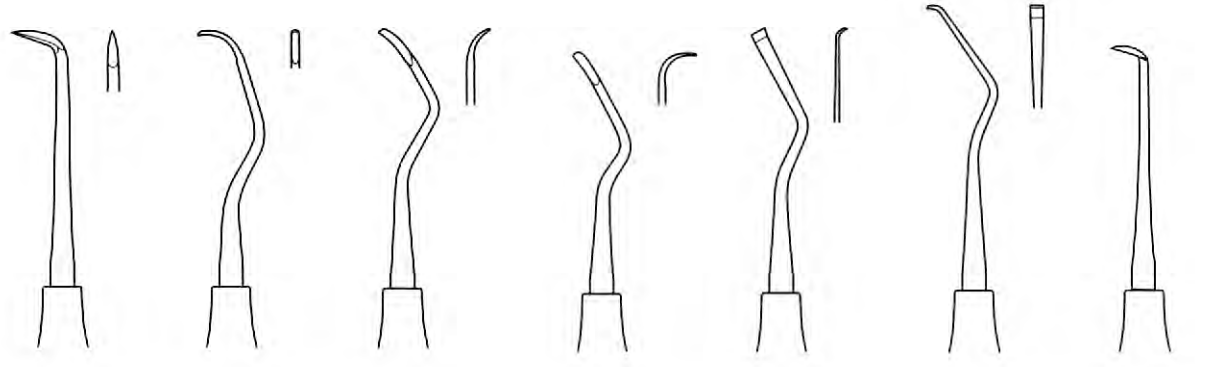

GM 56-1615
Goldman-Fox
Fig. 1

GM 56-1616
Goldman-Fox
Fig. 2

GM 56-1617
Goldman-Fox
Fig. 3

GM 56-1618
Goldman-Fox
Fig. 4

GM 56-1619
Goldman-Fox
Fig. 5

GM 56-1620
Goldman-Fox
Fig. 6

GM 56-1621
Goldman-Fox
Fig. 21

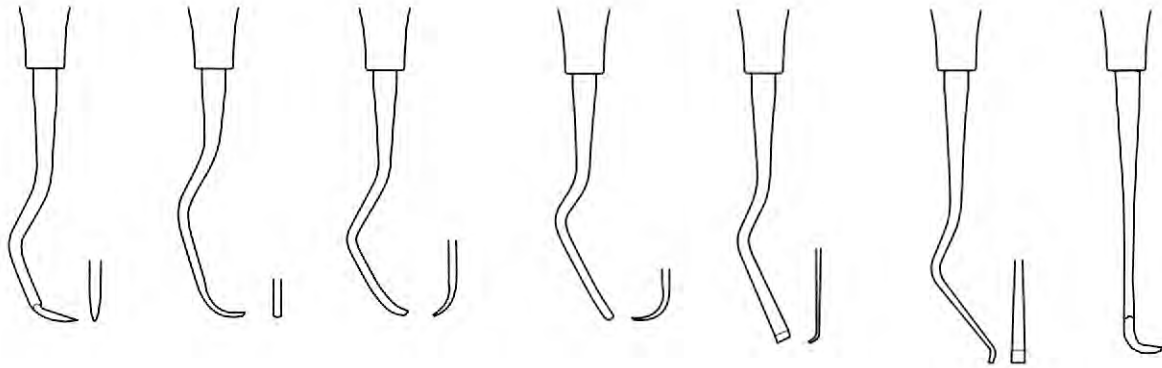

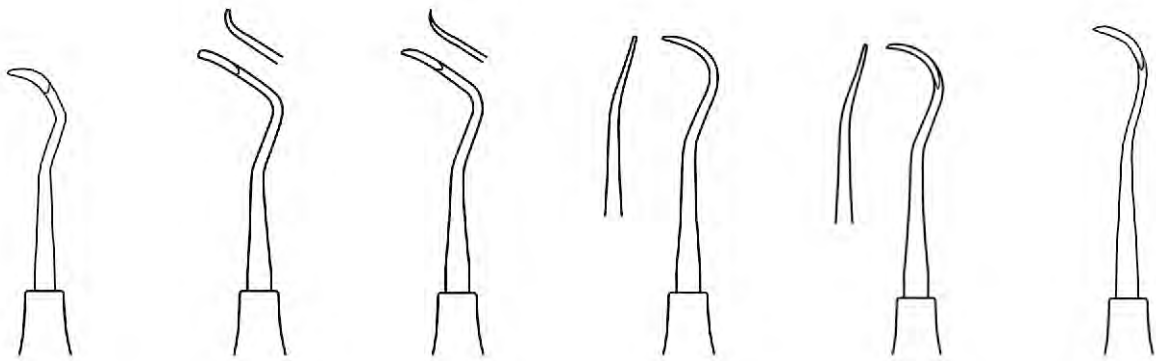

GM 56-1622
 McCall
 Fig. 11/12

GM 56-1623
 McCall
 Fig. 13S/14S

GM 56-1624
 McCall
 Fig. 13SM/14

GM 56-1625
 McCall
 Fig. 17/18

GM 56-1626
 McCall
 Fig. 17S/18S

GM 56-1627
 McCall
 Fig. 19/20

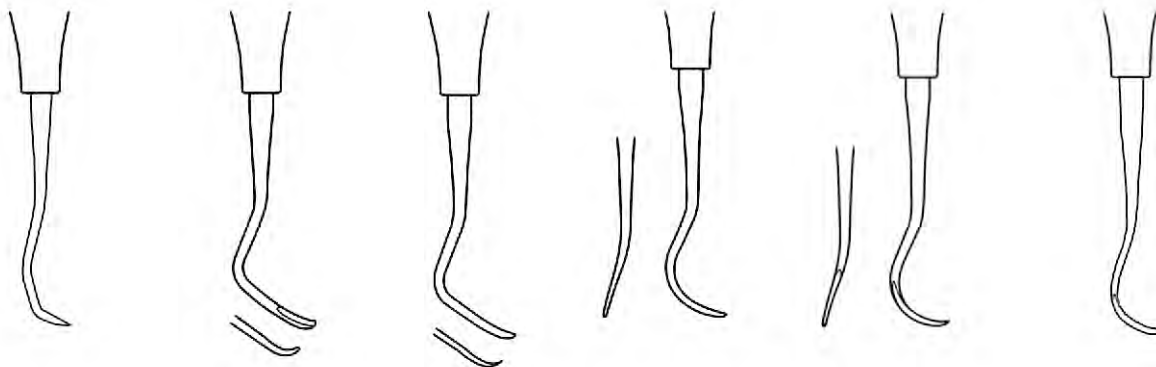

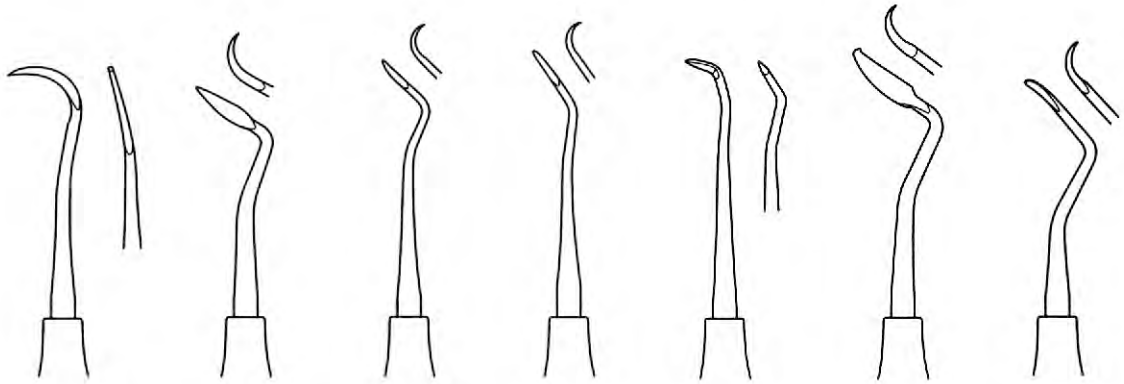

GM 56-1628 Hygienist Fig. H6/H7
 GM 56-1629 Fig. 204
 GM 56-1630 Fig. 204 S
 GM 56-1631 Fig. 204 SD
 GM 56-1632 Zürich
 GM 56-1633 Fig. CC 6
 GM 56-1634 Fig. M 23

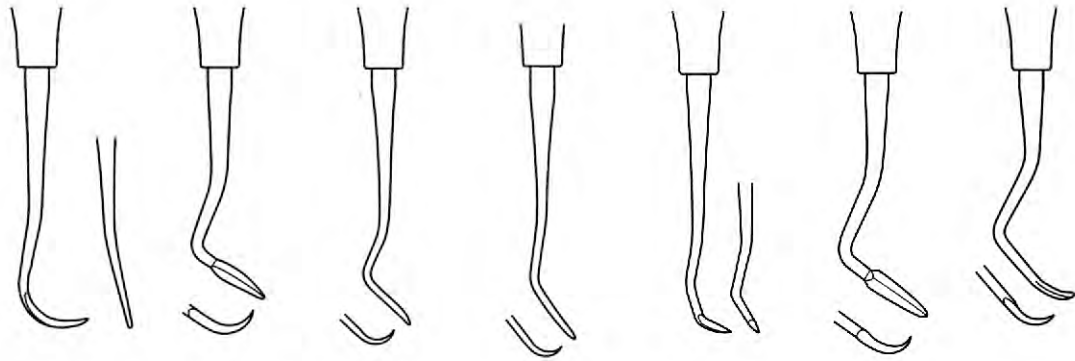

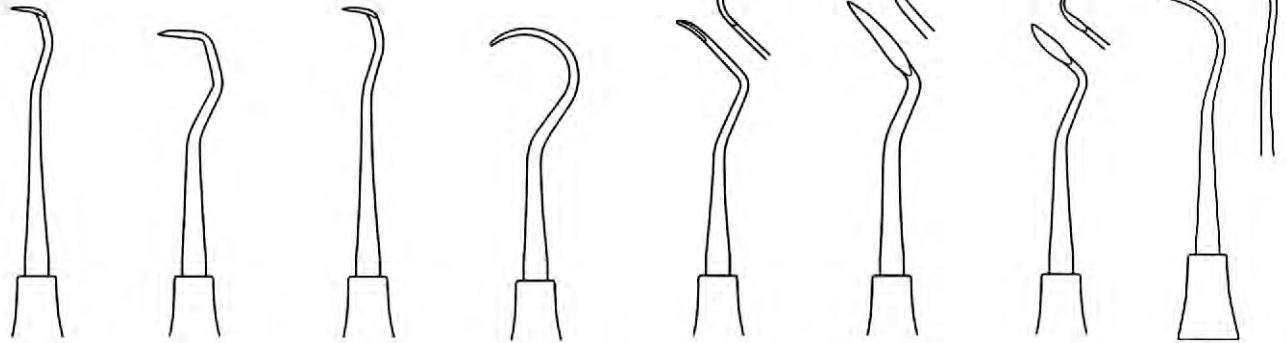

GM 56-1635
Hygienist-Towner
Fig. H5/33

GM 56-1636
Towner
Fig. U15/30

GM 56-1637
Towner
Fig. U15/33

GM 56-1638
Hygienist-Towner
Fig. H5/U15

GM 56-1639
Fig. U 135

GM 56-1640
Fig. CI 2/3

GM 56-1641
Taylor
Fig. T2/T3

GM 56-1642
Younger-Good
Fig. 33/34

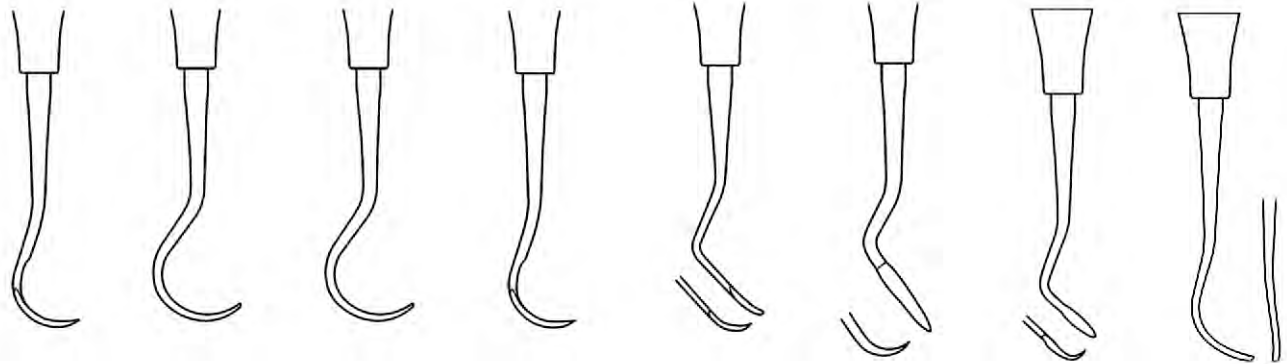

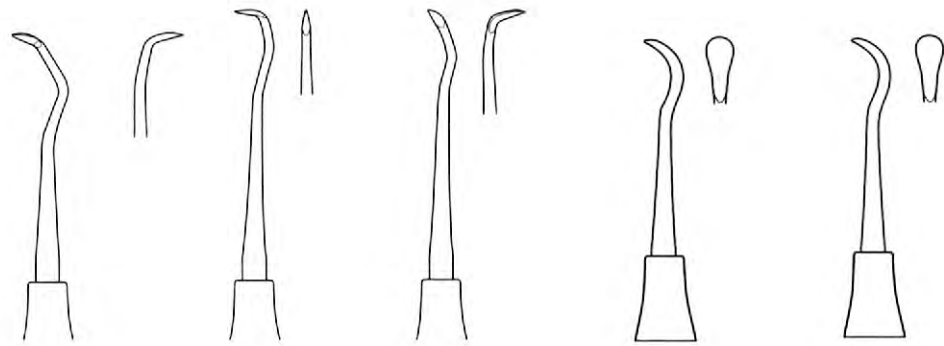

GM 56-1643
 Jacquette
 Fig. 31/32

GM 56-1644
 Jacquette
 Fig. 30/33

GM 56-1645
 Jacquette
 Fig. 34/35

GM 56-1646
 Cumine
 Fig. 33

GM 56-1647
 Mitchell
 Fig. 34

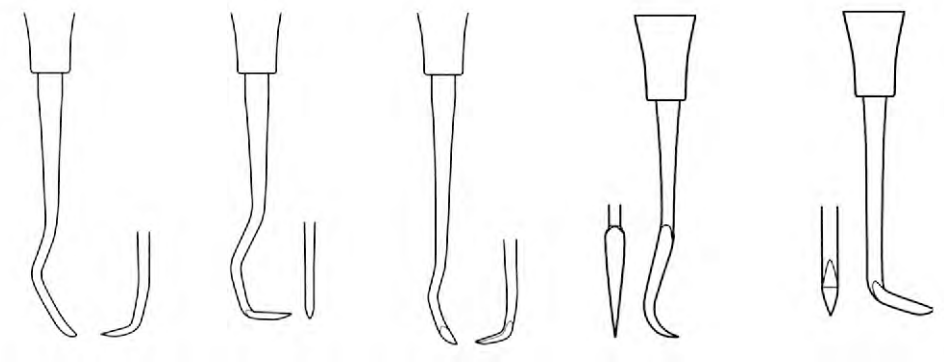

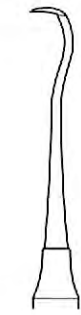

GM 56-1648
 Jacquette
 Fig. 33

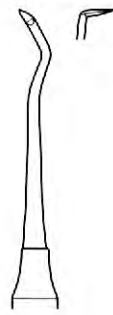

GM 56-1649
 Jacquette
 Fig. 34

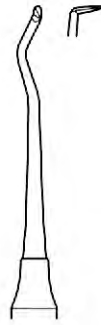

GM 56-1650
 Jacquette
 Fig. 35

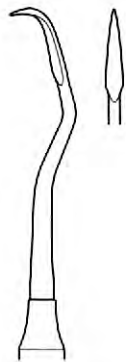

GM 56-1651
 Ward-Kirkland
 Fig. 1



GM 56-1652
 Crane-Kaplan
 Fig. 2



GM 56-1653
 Mercitan
 Fig. Sh5

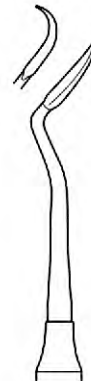

GM 56-1654
 Crane-Kaplan
 Fig. 3



GM 56-1655
 White
 Fig. 12B



57

- EN** Bone Currettes
- DE** Knochenküretten
- ES** Curetas de hueso

Page 79 to 84

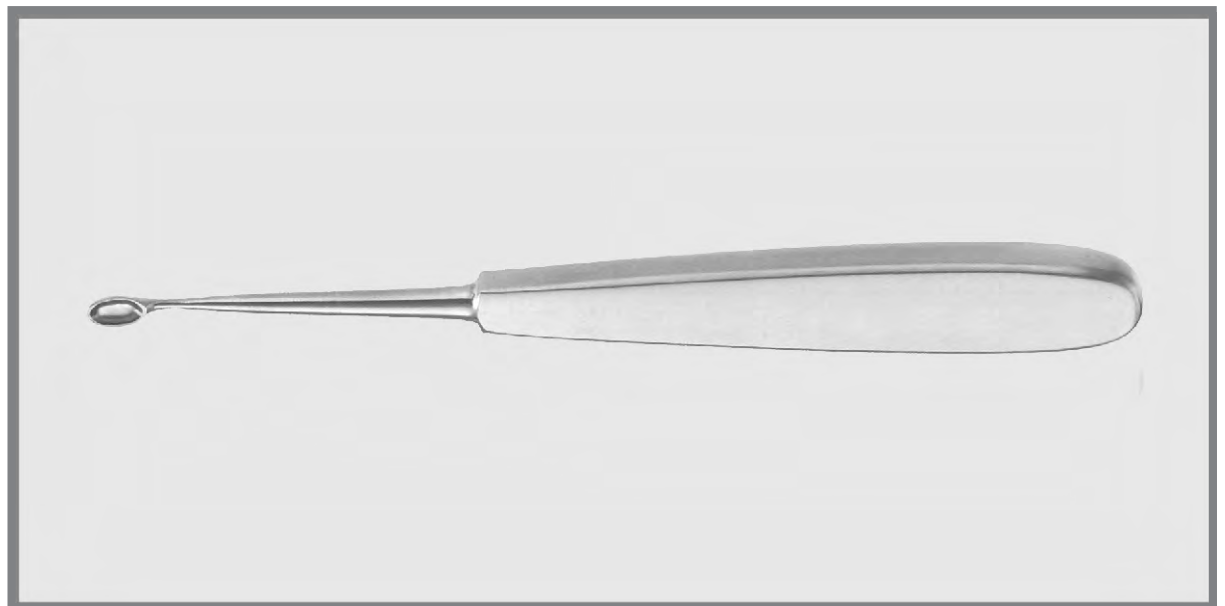

GM 57-1701
GM 57-1702

GM 57-1703
GM 57-1704



WILLIGER



Fig. 00



Fig. 00



Fig. 0



Fig. 0

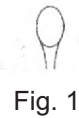

Fig. 1



Fig. 1



Fig. 2

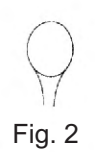

Fig. 2

Fig. 00
Fig. 0
Fig. 1
Fig. 2

GM 57-1705 GM 57-1709
GM 57-1706 GM 57-1710
GM 57-1707 GM 57-1711
GM 57-1708 GM 57-1712

GM 57-1713 GM 57-1717
GM 57-1714 GM 57-1718
GM 57-1715 GM 57-1719
GM 57-1716 GM 57-1720



Mod. USA



Fig. 1	GM 57-1721		
Fig. 2	GM 57-1722		
Fig. 3	GM 57-1723		
Fig. 4	GM 57-1724		
Fig. 5	GM 57-1725		
Fig. 6	GM 57-1726		
		R	L
		GM 57-1727	GM 57-1733
		GM 57-1728	GM 57-1734
		GM 57-1729	GM 57-1735
		GM 57-1730	GM 57-1736
		GM 57-1731	GM 57-1737
		GM 57-1732	GM 57-1738

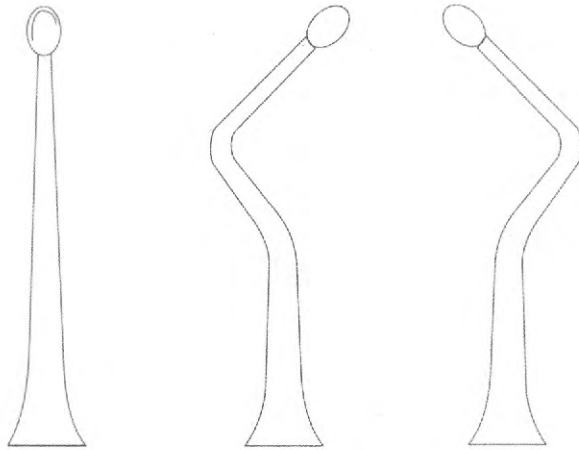

CHOMPRET
 GM 57-1739

GM 57-1740 R
 GM 57-1741 L



GM 57-1748- GM 57-1750R-
 GM 57-1749 GM 57-1751R



GM 57-1742
 Fig. 00/00

GM 57-1743
 Fig. 0/0

GM 57-1744
 Fig. 1/1



GM 57-1745
 Fig. 00/00

GM 57-1746
 Fig. 0/0

GM 57-1747
 Fig. 1/1



HEMINGWAY
 18 CM/7"

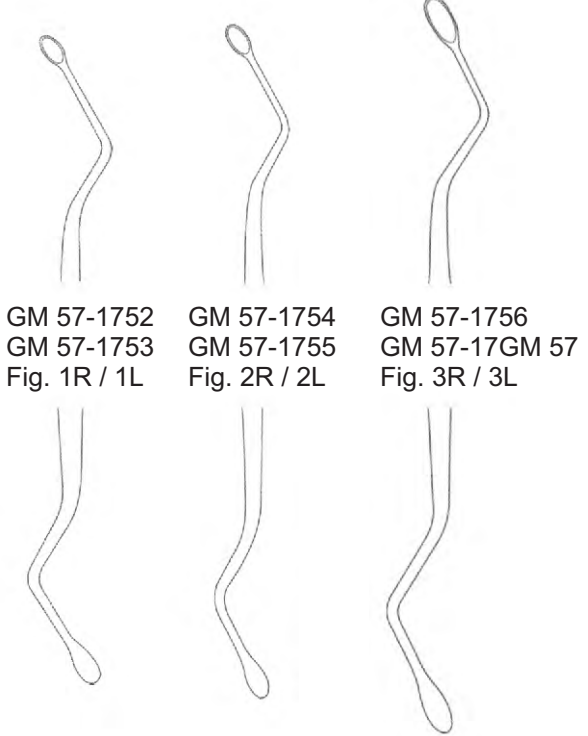

GM 57-1752
 GM 57-1753
 Fig. 1R / 1L

GM 57-1754
 GM 57-1755
 Fig. 2R / 2L

GM 57-1756
 GM 57-17GM 57
 Fig. 3R / 3L

WILLGER

MARTINI



5,5 mm Ø9,5 mm
 HEMINGWAY
 17 cm/6 ¾"

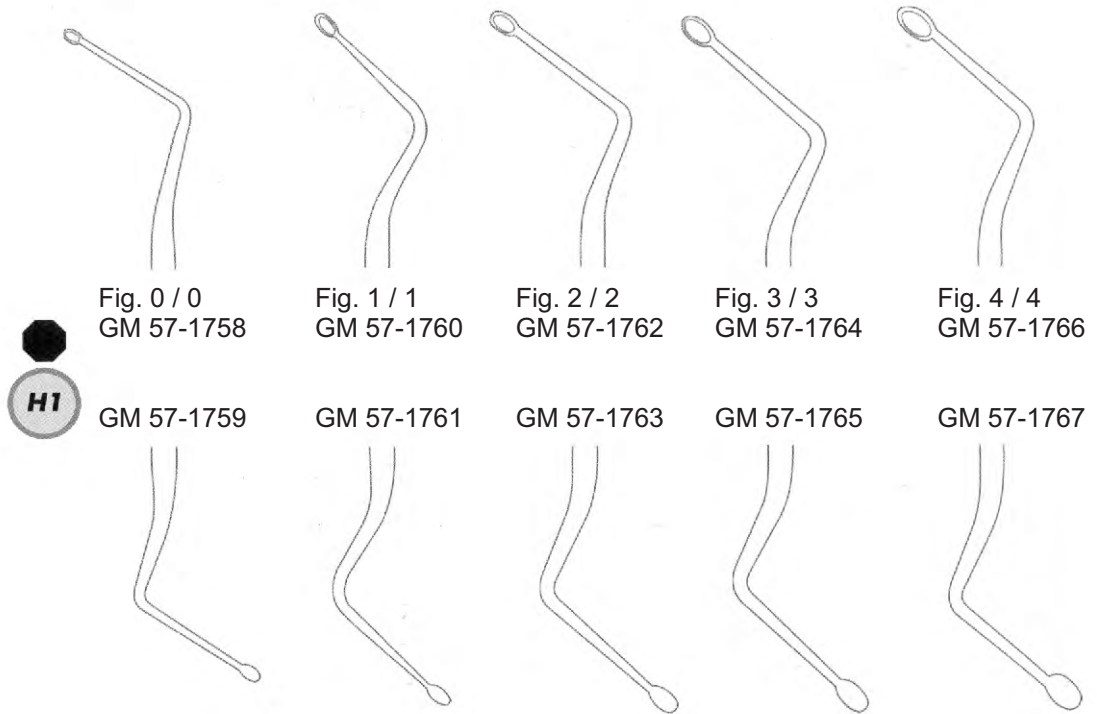

GM 57-1768 GM 57-1770
 GM 57-1769 GM 57-1771

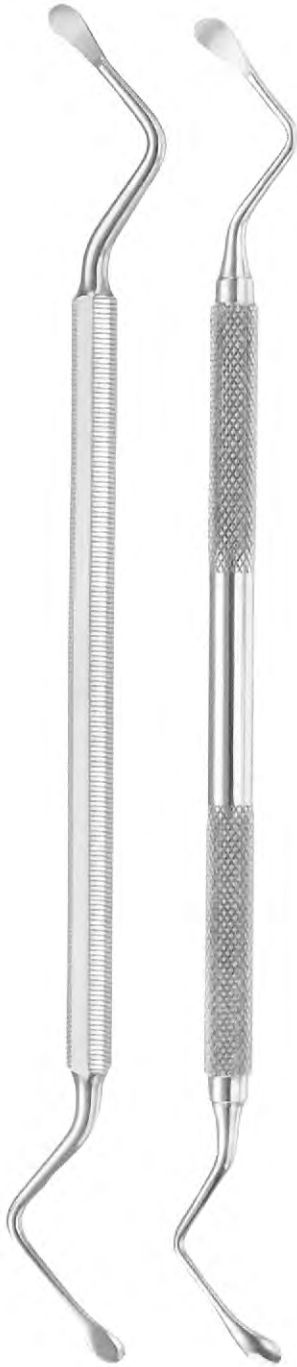

LUCAS
 17 cm/6¾"



GM 57-1772
 GM 57-1773
 Fig. 1 / 1



GM 57-1774
 GM 57-1775
 Fig. 2 / 2



GM 57-1776
 GM 57-1777
 Fig. 3 / 3



GM 57-1778
 GM 57-1779
 Fig. 4 / 4

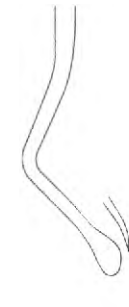



Fig. 4



Fig. 5



Fig. 1



Fig. 2



Fig. 3

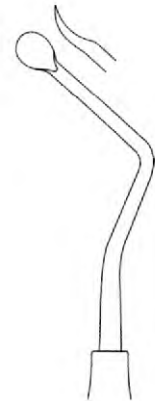

Fig. 4



MEAD
 GM 57-1780 GM 57-1781



GM 57-1782



MILLER-COLBURN
 GM 57-1783



GM 57-1784

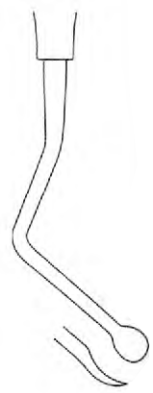

GM 57-1785



58

- EN** Excavators
- DE** Bagger
- ES** Excavadoras

Page 85 to 89





GM 58-1800
Fig. 72/73

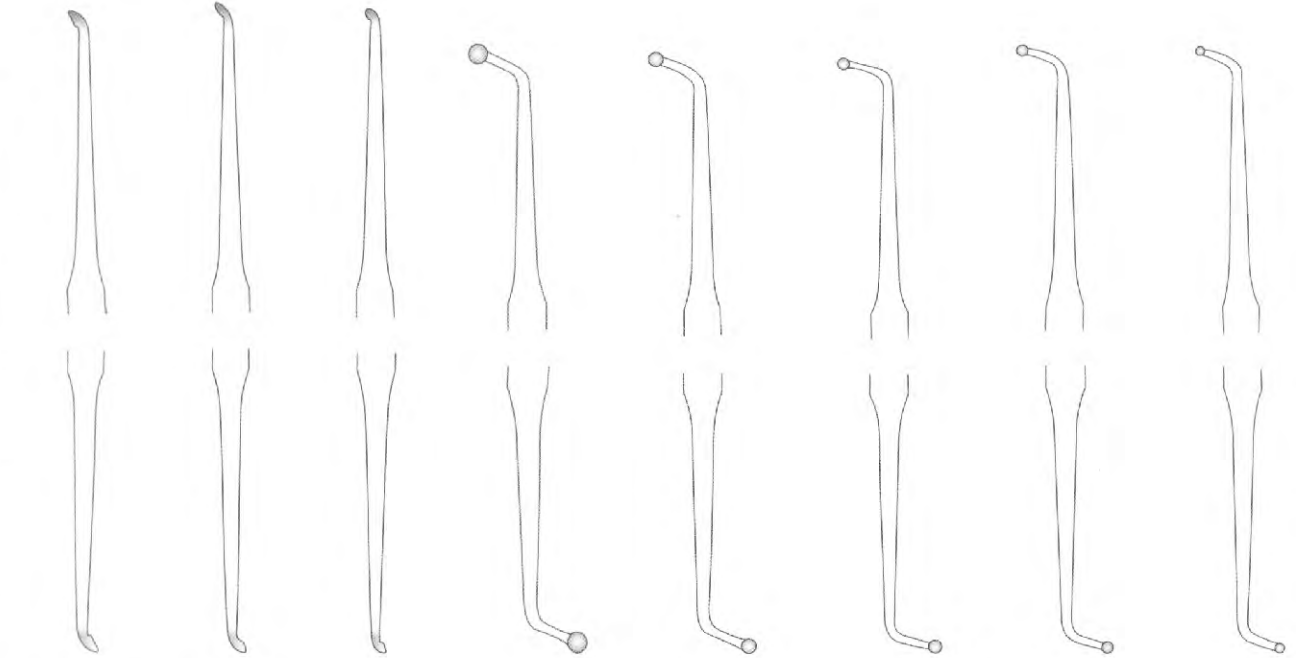

GM 58-1801 Fig. 73/74 GM 58-1802 Fig. 74/111 GM 58-1803 Fig. 111/112 GM 58-1804 Fig. 113/114 GM 58-1805 Fig. 115/116 GM 58-1806 Fig. 117/118 GM 58-1807 Fig. 119/120 GM 58-1808 Fig. 1121/122

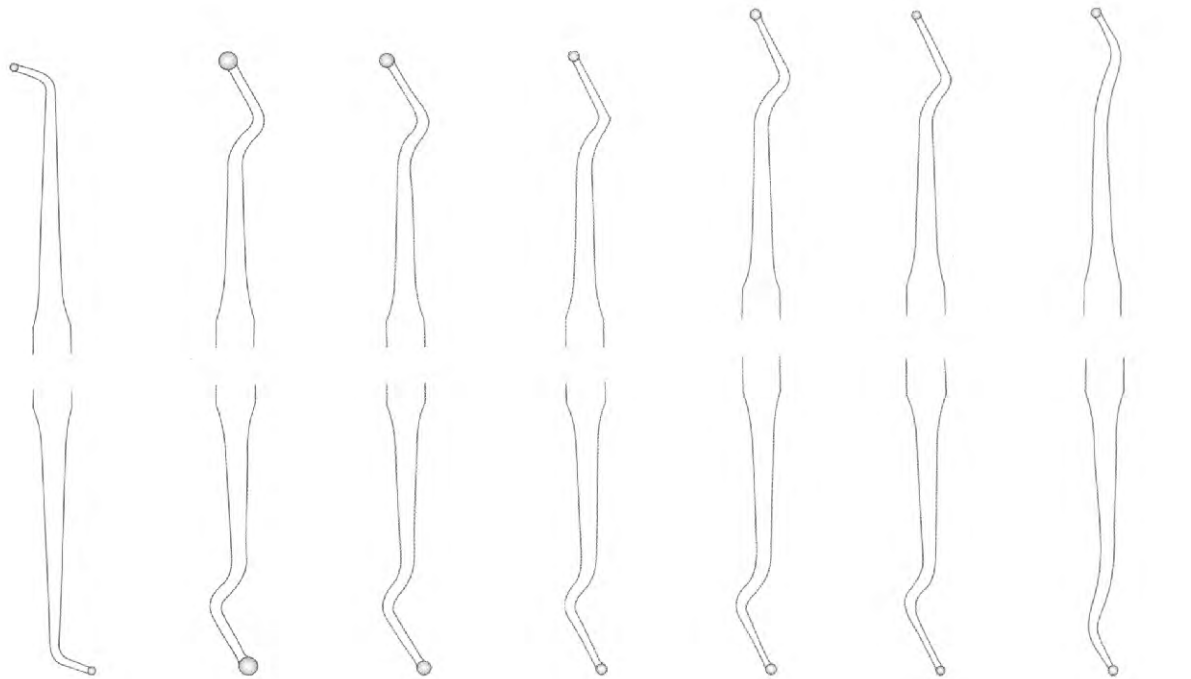

GM 58-1809 Fig. 123/124 GM 58-1810 Fig. 125/126 GM 58-1811 Fig. 127/128 GM 58-1812 Fig. 129/130 GM 58-1813 Fig. 131/132 GM 58-1814 Fig. 133/134 GM 58-1815 Fig. 155/156

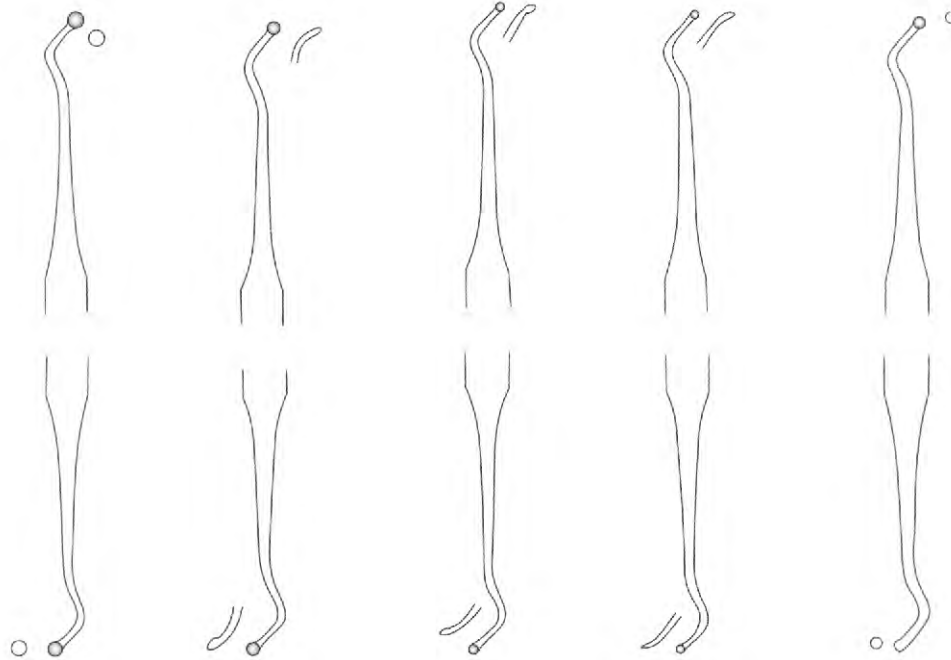

GM 58-1816 Fig.139/140 GM 58-1817 Fig.141/142 GM 58-1818 Fig.159/160 GM 58-1819 Fig.161/162 GM 58-1820 Fig.165/166

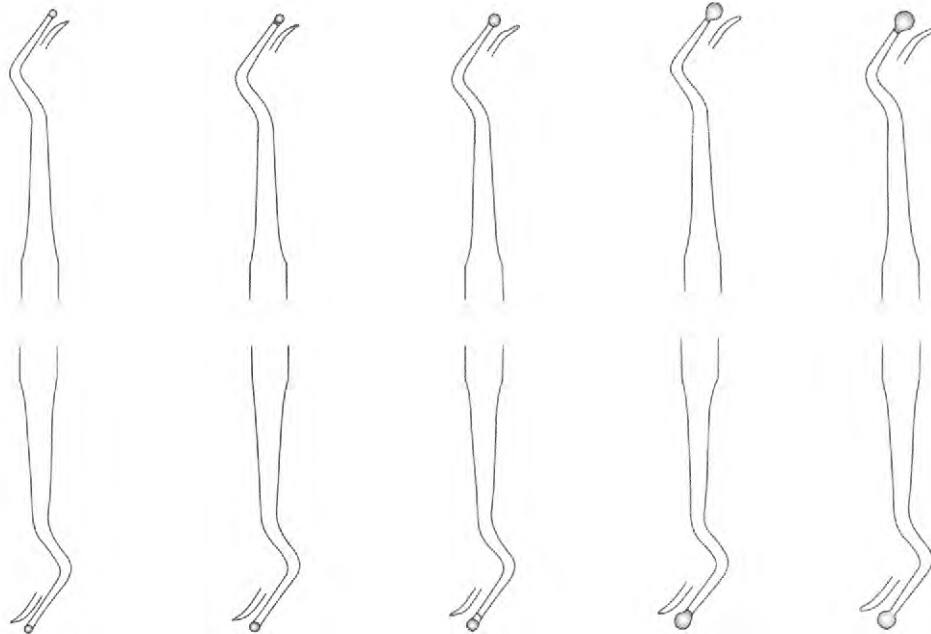

GM 58-1821 Fig.171/172 GM 58-1822 Fig.173/174 GM 58-1823 Fig.175/176 GM 58-1824 Fig.177/178 GM 58-1825 Fig.179/180



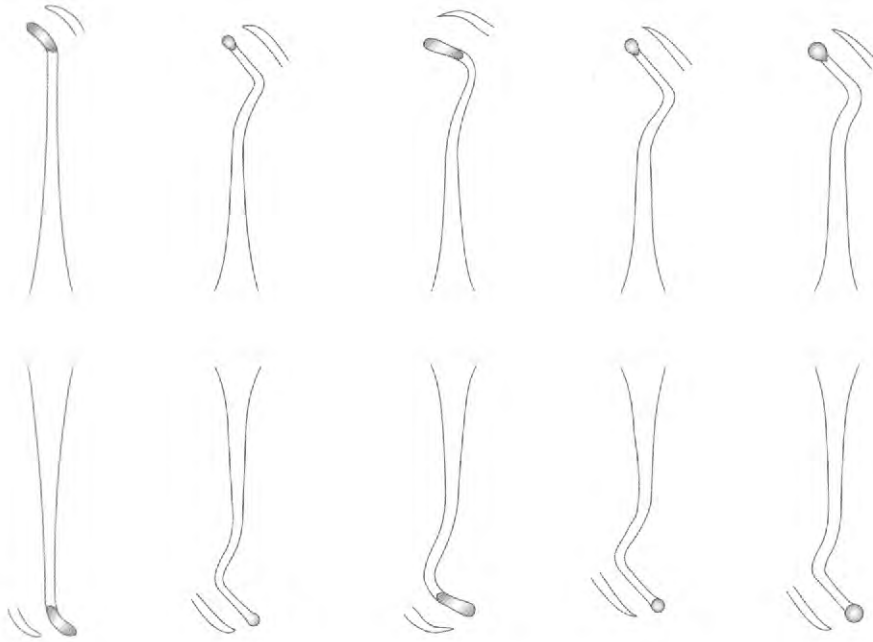

GM 58-1826 Fig. 5 GM 58-1827 Fig. 13 **WHITE** GM 58-1828 Fig. 14 GM 58-1829 Fig. 15 GM 58-1830 Fig. 17



GM 58-1831 Fig. 18 GM 58-1832 Fig. 19 **WHITE** GM 58-1833 Fig. 20 GM 58-1834 Fig. 23 GM 58-1835 Fig. 25

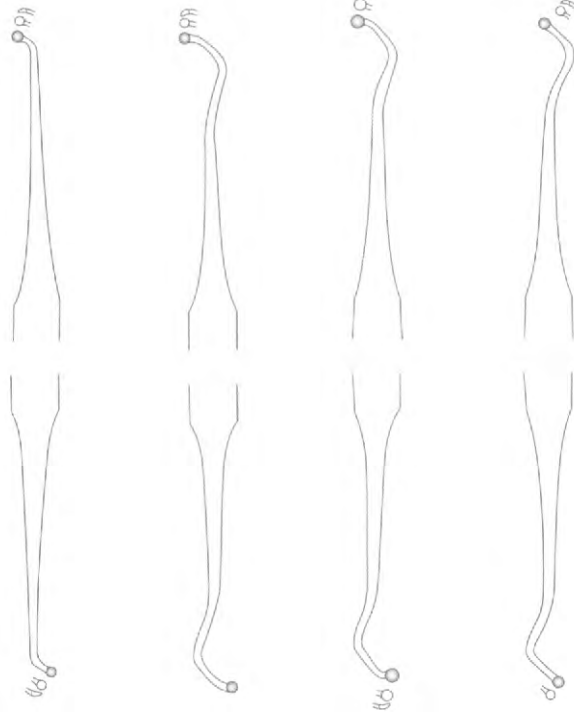

Fig. 5 GM 58-1836
 Fig. 13 GM 58-1837
 Fig. 14 GM 58-1838
 Fig. 17 GM 58-1839

GM 58-1840 GM 58-1841 GM 58-1842 GM 58-1843

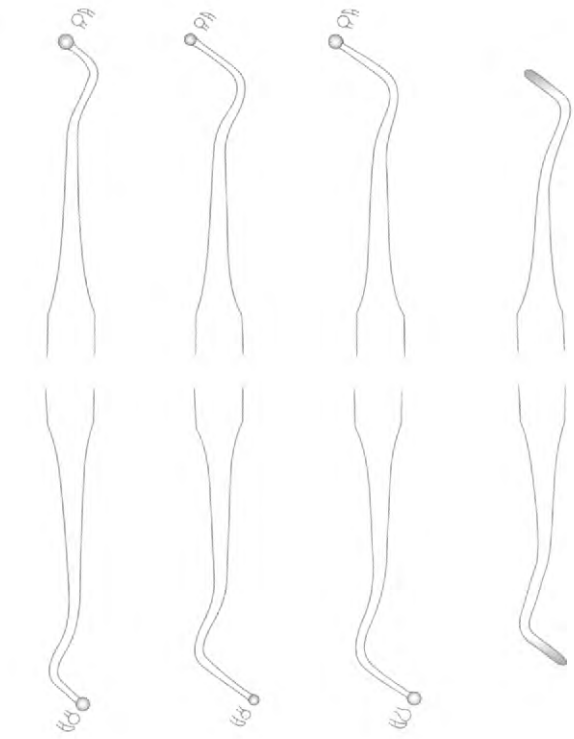

Fig. 18 GM 58-1844
 Fig. 31 GM 58-1845
 Fig. 33 GM 58-1846
 Fig. 35 GM 58-1847

GM 58-1848 GM 58-1849 GM 58-1850 GM 58-1851





GM 58-1852
Fig. 5/6

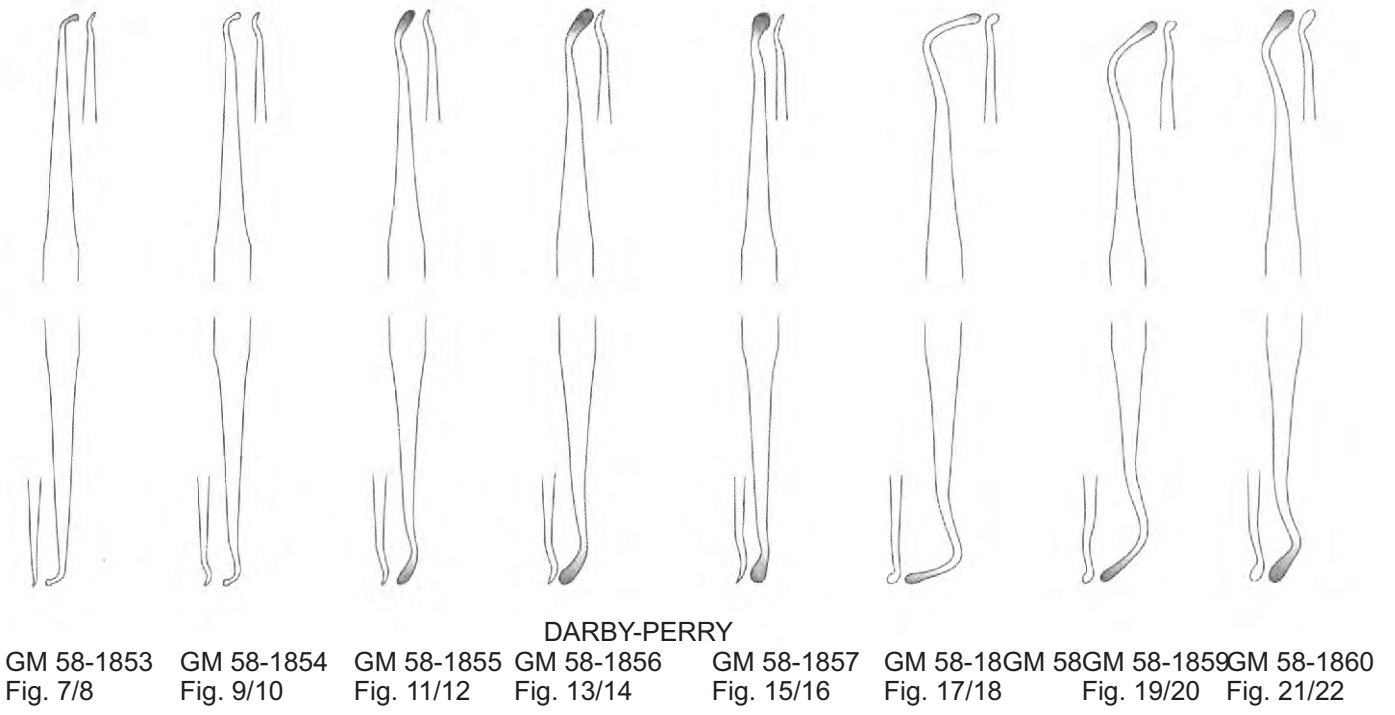

DARBY-PERRY

GM 58-1853 Fig. 7/8 GM 58-1854 Fig. 9/10 GM 58-1855 Fig. 11/12 GM 58-1856 Fig. 13/14 GM 58-1857 Fig. 15/16 GM 58-18GM 58GM 58-1859GM 58-1860 Fig. 17/18 Fig. 19/20 Fig. 21/22

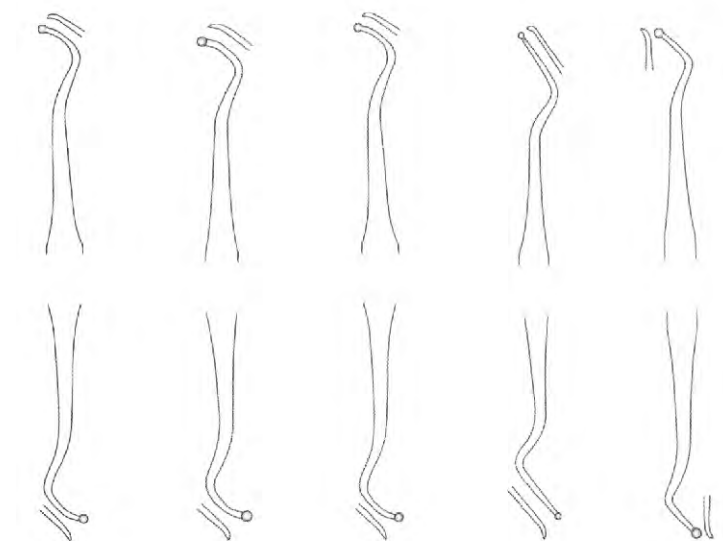

GILLET

GM 58-1861 Fig. 4/5 GM 58-1862 Fig. 6/7 GM 58-1863 Fig. 7/8 GM 58-1864 Fig. 12/13 GM 58-1865 Fig. 14/15

59

- EN** Wax Proclein
- DE** Wachs-Porzellan
- ES** cera Porcelana

Page 90 to 94

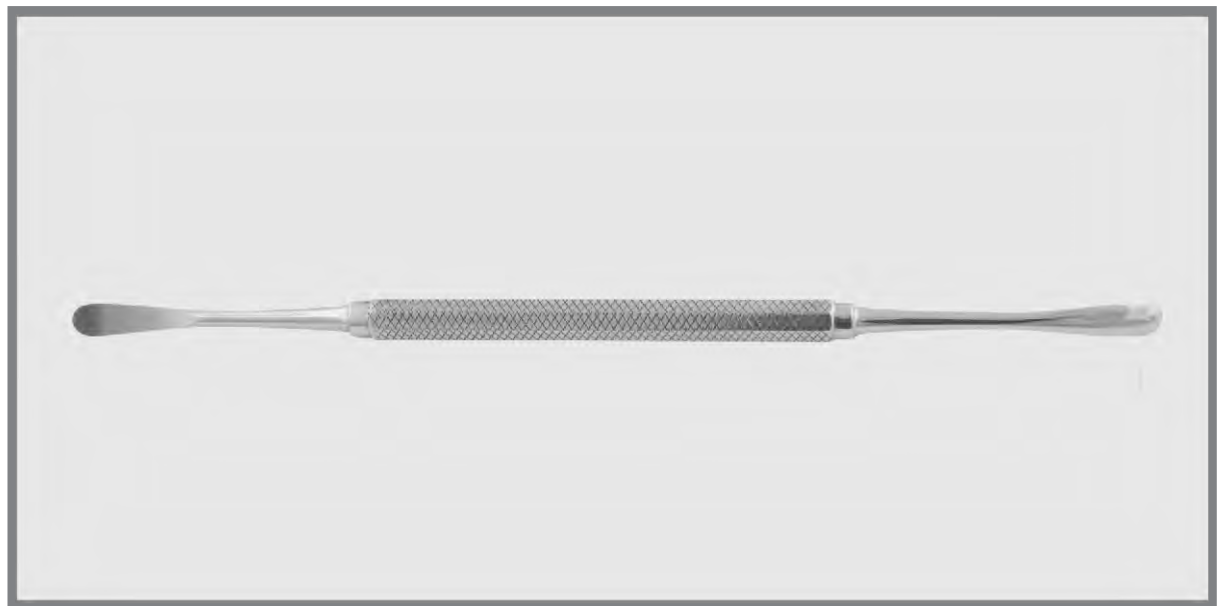



5,5 mm



H1
 Ø9,5 mm



GM 59-1901
 Fig. 1



GM 59-1902
 Fig. 2



GM 59-1903
 Fig. 3



GM 59-1904
 Fig. 4



GM 59-1905
 Fig. 5



GM 59-1906H GM 59-1907H GM 59-1908H GM 59-1909H GM 59-1910H

Aluminium

GM 59-1911

GM 59-1912

GM 59-1913

GM 59-1914

GM 59-1915

gold

green

blue

red

silver

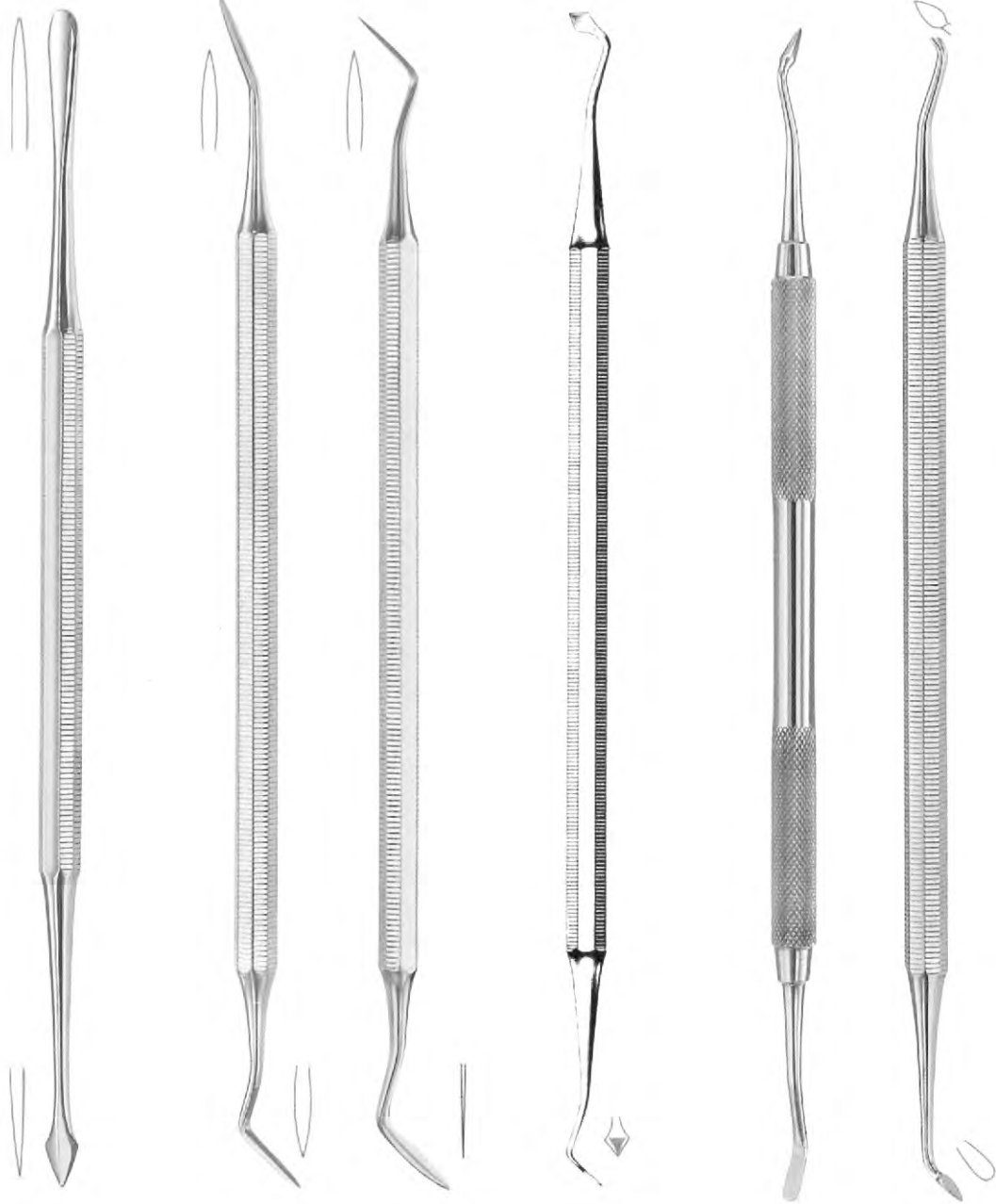

GRITMAN
GM 59-1916

WARD
GM 59-1917 Fig. 1
GM 59-1918 Fig. 2

FRAHM
GM 59-1919

SHOSHAN
GM 59-1920
SHO-A

W.A.C.D
GM 59-1921



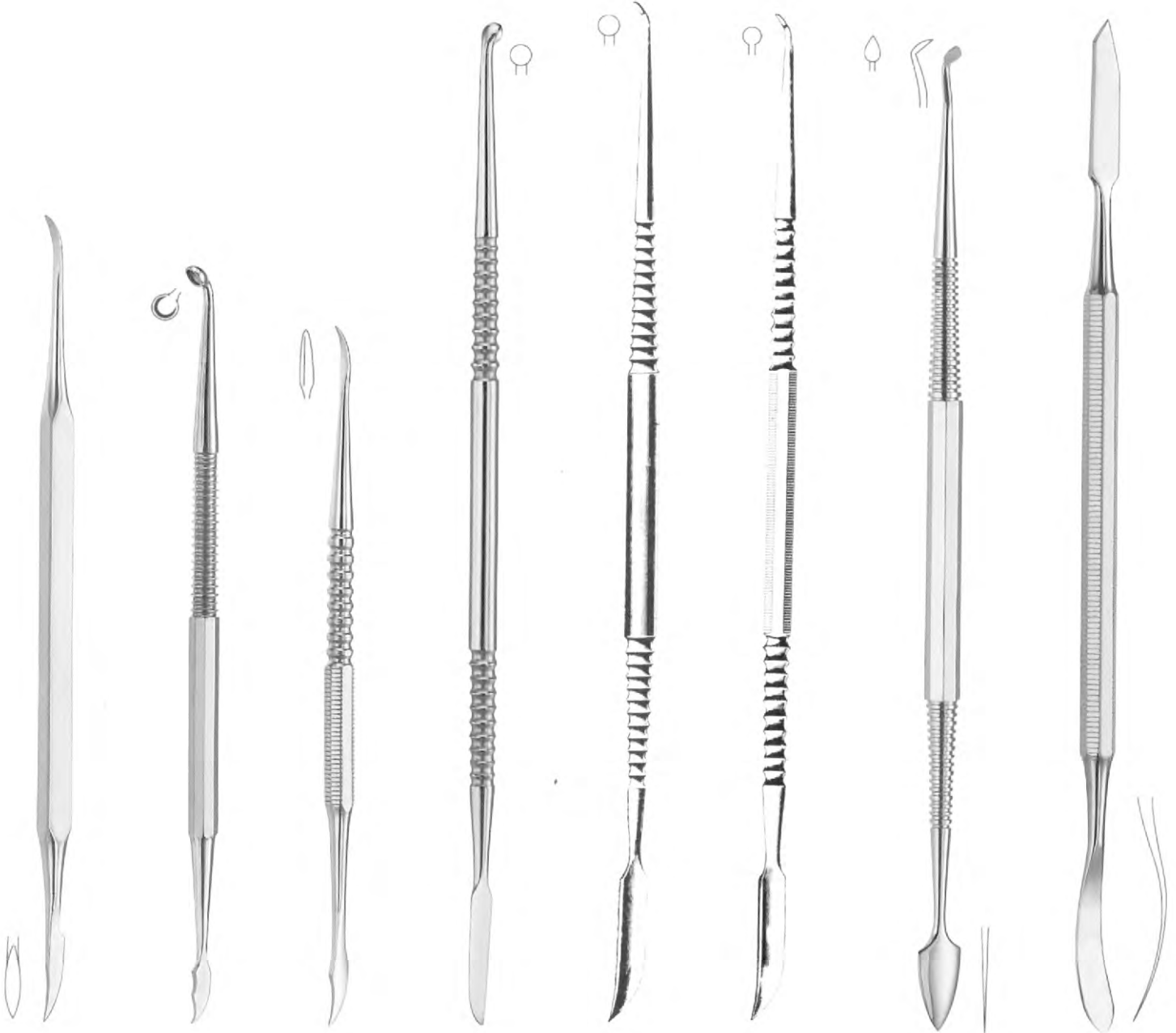

HYLIN GM 59-1922 **ZAHLE** GM 59-1923 **LE CRON** GM 59-1926
GM 59-1924 **GM 59-1925** **GM 59-1927**
VEHE GM 59-1928 **FIELDSTAD** GM 59-1929



ROACH
 GM 59-1930 GM 59-1931

RIEGER
 GM 59-1932

GM 59-1933
 Fig. 1

GM 59-1934
 Fig. 2

FRAHM
 GM 59-1935
 Fig. 6

GM 59-1936
 Fig. 10

GM 59-1937
 Fig. 6/10

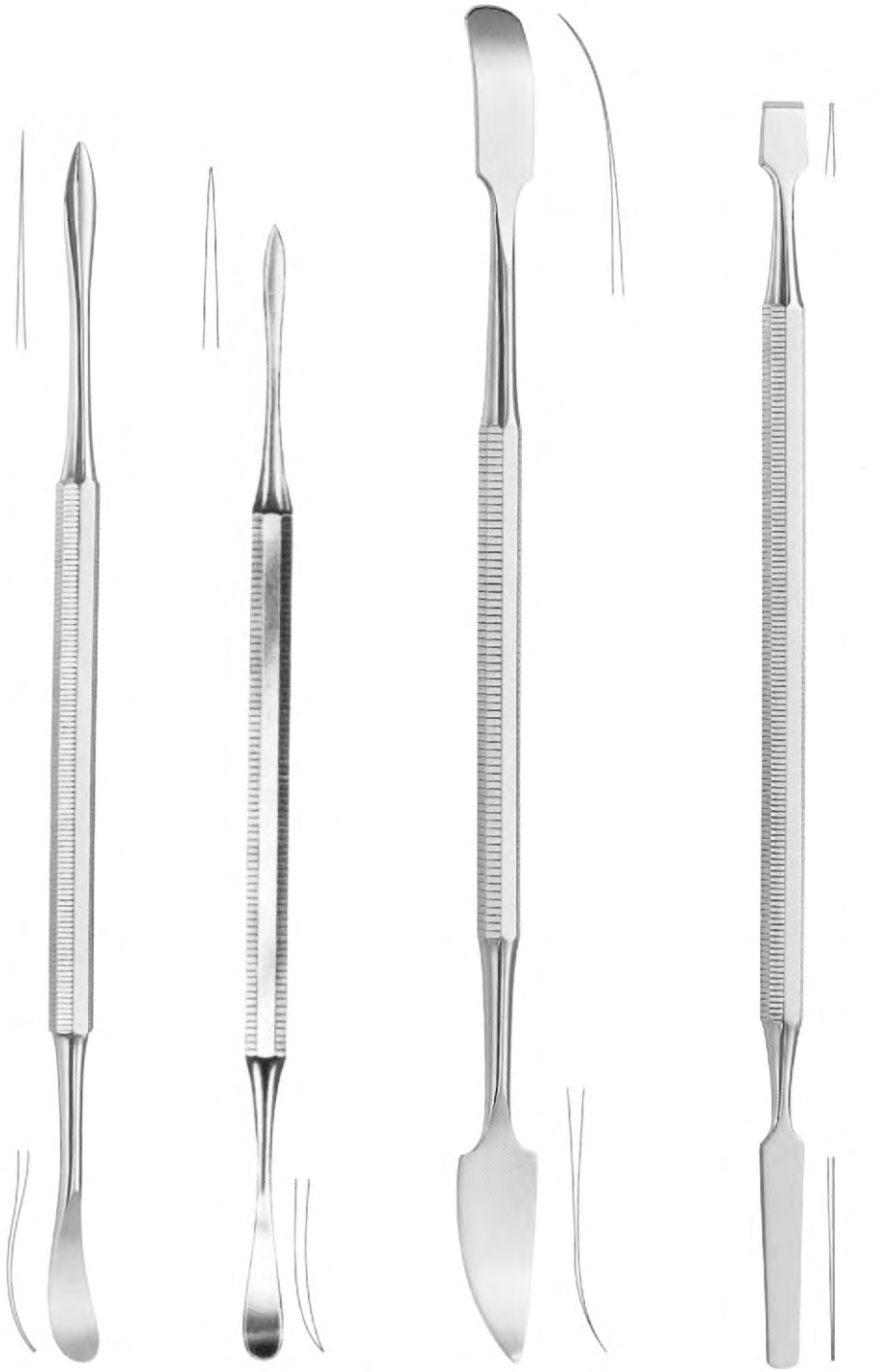

BEALE
 GM 59-1938 GM 59-1939
 Fig. 7A

GRITMAN
 GM 59-1940
 19,5 cm/7 1/2"

WESTON
 GM 59-1941

60

- EN** Filling Instruments
- DE** Füllungsinstrumente
- ES** Actos de llenado

Page 95 to 105



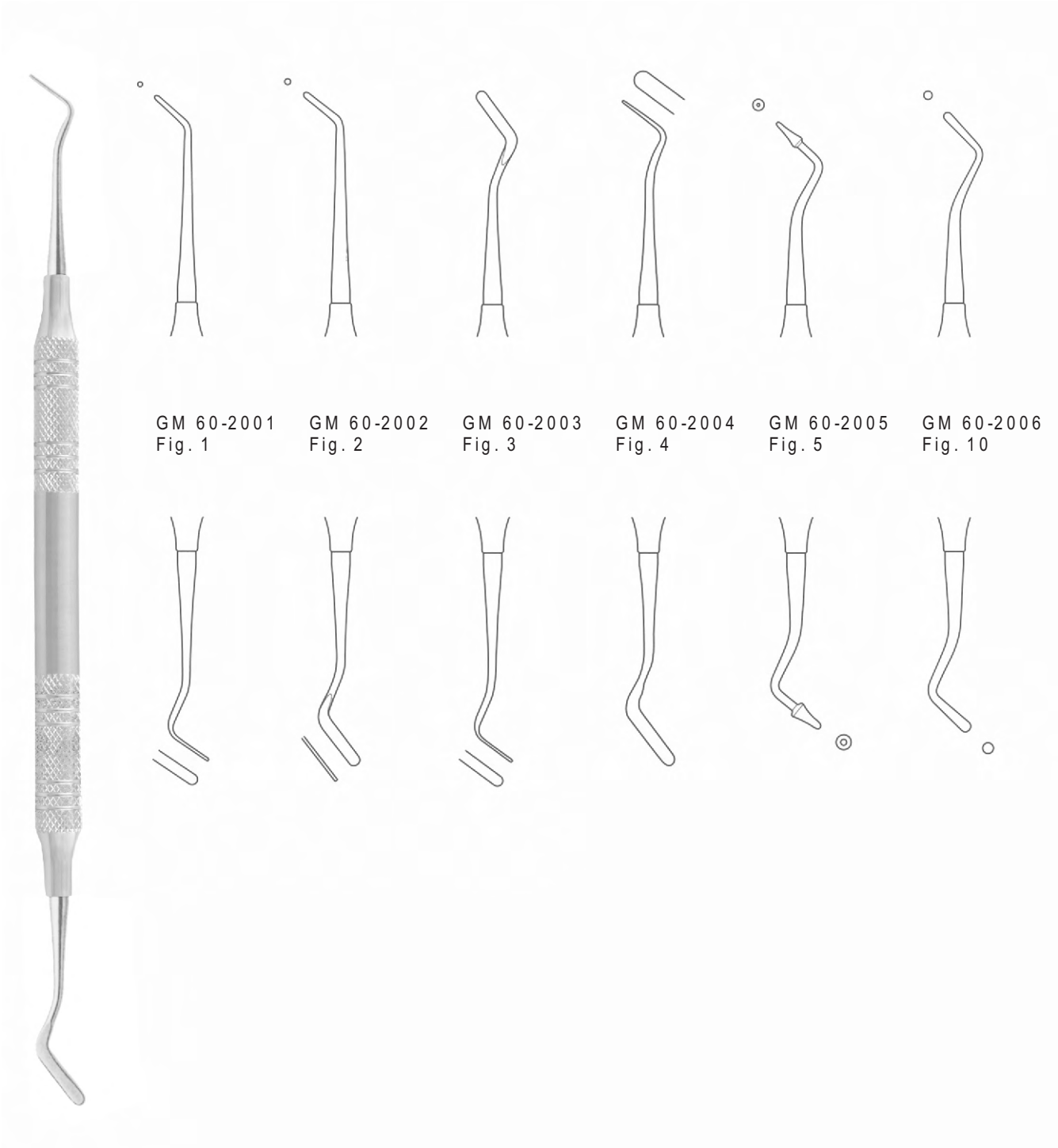

GM 60-2001
Fig. 1

GM 60-2002
Fig. 2

GM 60-2003
Fig. 3

GM 60-2004
Fig. 4

GM 60-2005
Fig. 5

GM 60-2006
Fig. 10

Note: Titanium Coated Points are available on customer demand.

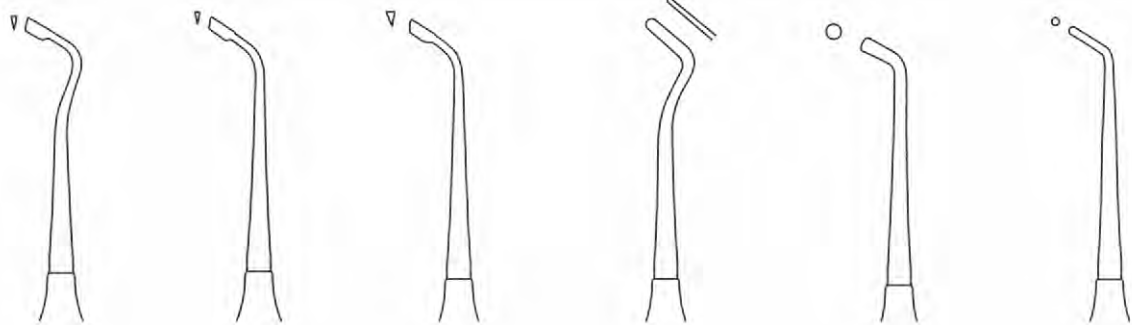

GM 60-2007
 Fig. 1
 Felt

GM 60-2008
 Fig. 2
 Felt

GM 60-2009
 Fig. 3
 Felt

GM 60-2010
 Fig. 4
 Felt

GM 60-2011
 Fig. 5
 Felt

GM 60-2012
 Fig. 6
 Felt

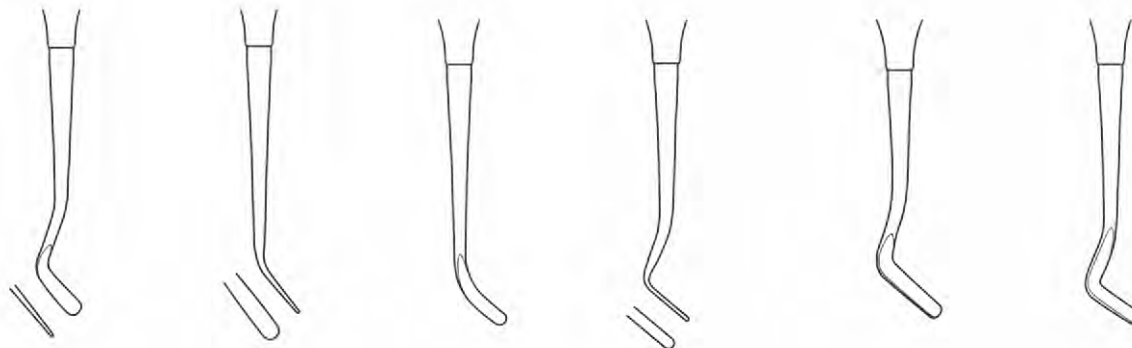

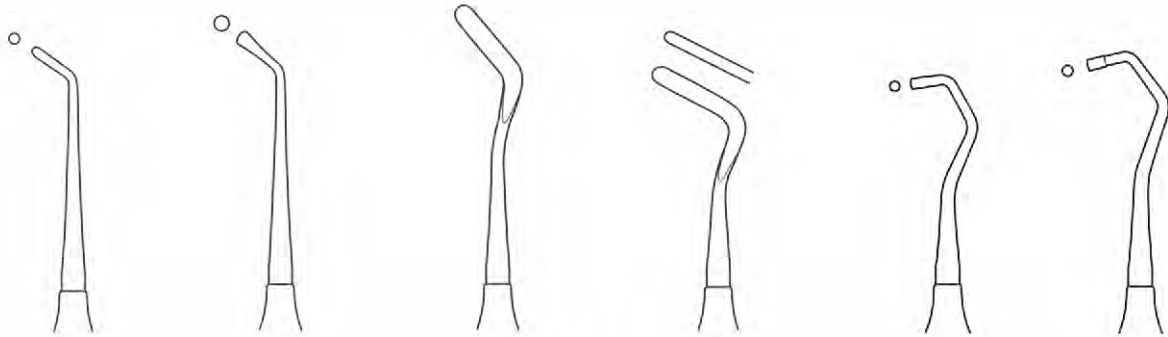

GM 60-2013
 Fig. 1
 Goldstein

GM 60-2014
 Fig. 2
 Goldstein

GM 60-2015
 Fig. 3
 Goldstein

GM 60-2016
 Fig. 4
 Goldstein

GM 60-2017
 Fig. 9/10

GM 60-2018
 Fig. 11/12

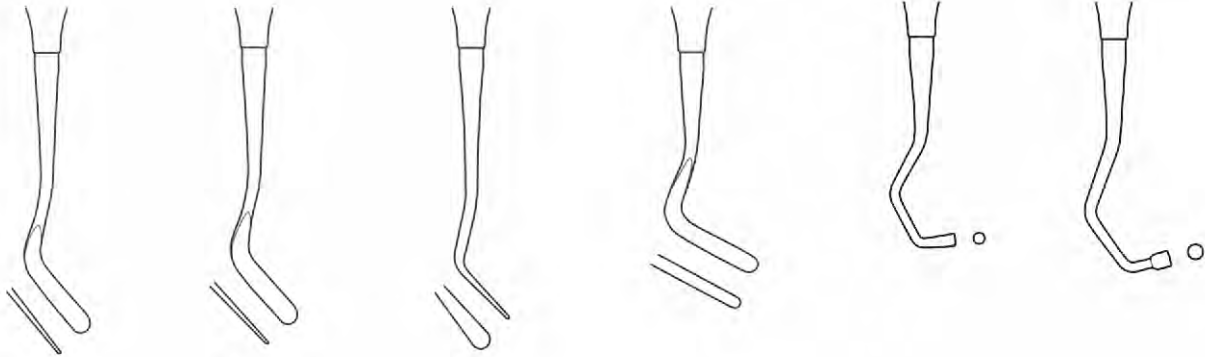



GM 60-2019
Fig. SB



GM 60-2020
Fig. 29/2B



GM 60-2021
Fig. L1
Loesche



GM 60-2022
Fig. L2
Loesche



GM 60-2023
Fig. 18
Ball Burnisher



GM 60-2024
Fig. 26/27S
Ball Burnisher



GM 60-2025
Fig. 28/29
Ball Burnisher

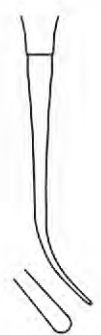



GM 60-2026
Fig. 1S



GM 60-2027
Fig. 2S



GM 60-2028
Fig. 3S



GM 60-2029
Fig. 4S



GM 60-2030
Fig. 1P



GM 60-2031
Fig. 2P



GM 60-2032
Fig. 3P



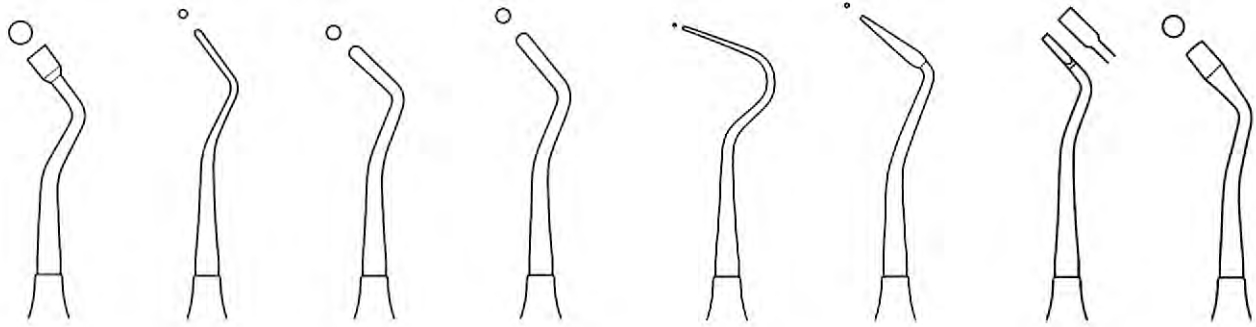

GM 60-2033
Fig. 4P

GM 60-2034
Fig. 1D

GM 60-2035
Fig. 2D

GM 60-2036
Fig. 3D

GM 60-2037
Fig. M1
Markley

GM 60-2038
Fig. M2

GM 60-2039
Fig. M3

GM 60-2040
Fig. M4

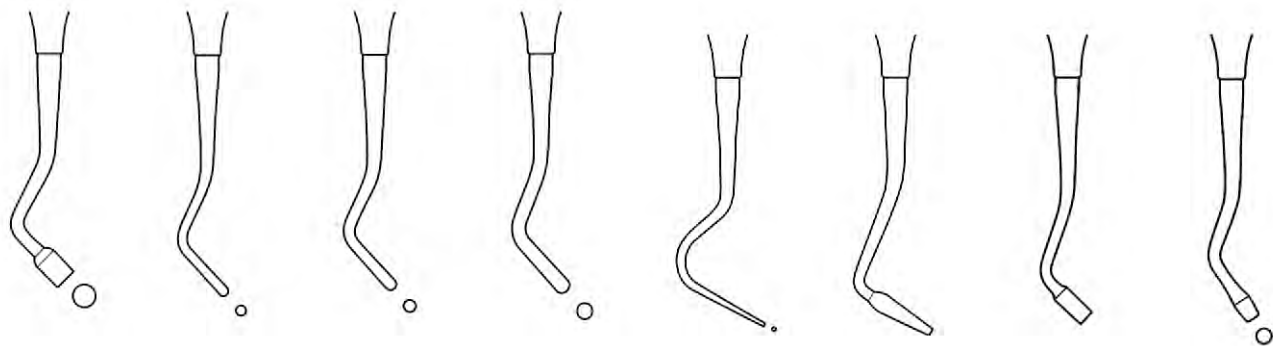

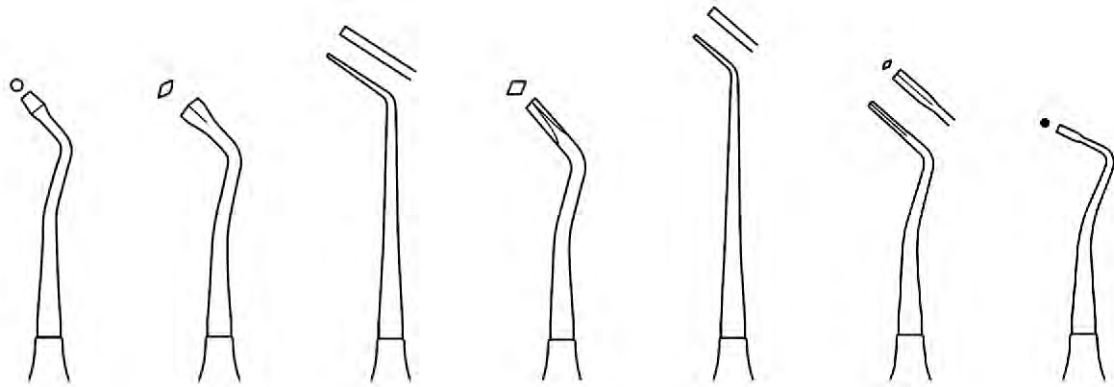

GM 60-2041 Fig. M5
 GM 60-2042 Fig. M6
 GM 60-2043 Fig. H1 Hollenback
 GM 60-2044 Fig. H2 Hollenback
 GM 60-2045 Fig. H3 Hollenback
 GM 60-2046 Fig. H4 Hollenback
 GM 60-2047 Fig. MQ 1S

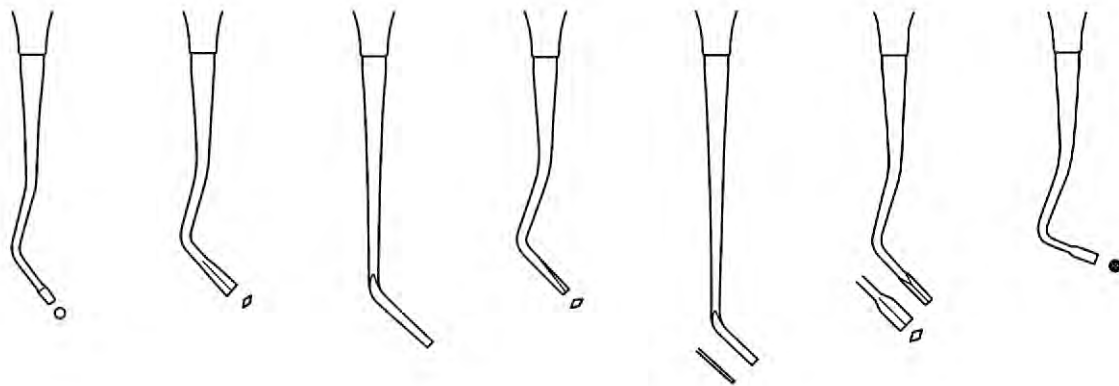

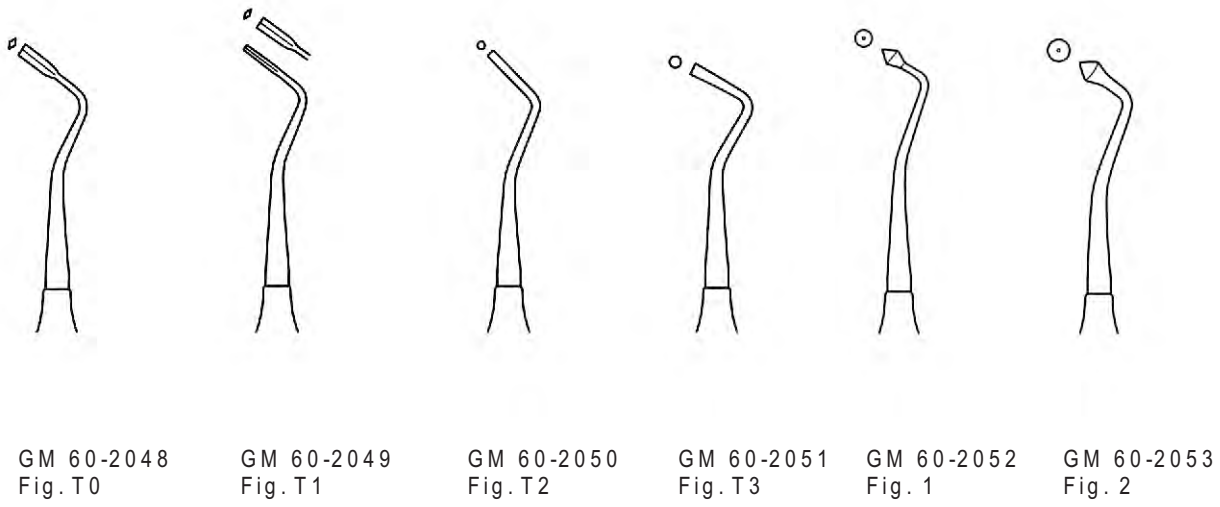

GM 60-2048
Fig. T0

GM 60-2049
Fig. T1

GM 60-2050
Fig. T2

GM 60-2051
Fig. T3

GM 60-2052
Fig. 1

GM 60-2053
Fig. 2

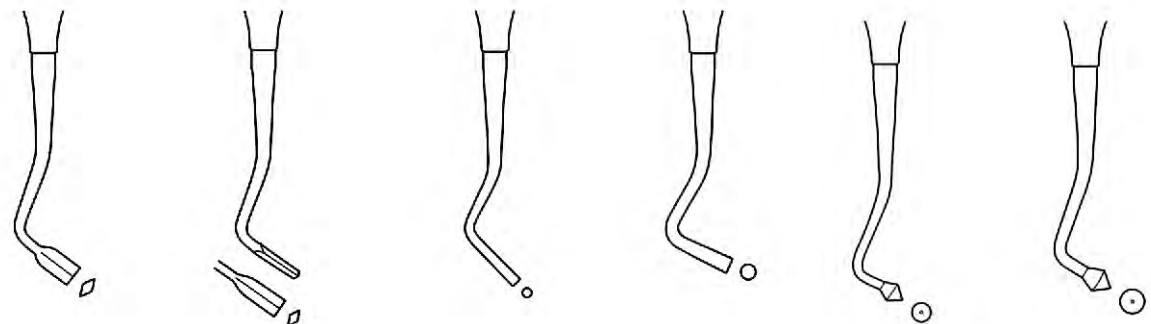



GM 60-2054
Fig. 3

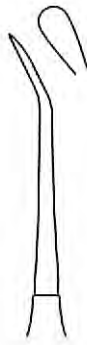

GM 60-2055
Fig. WO 1
Woodson

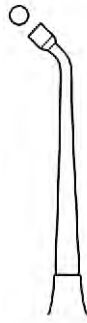

GM 60-2056
Fig. WO 2
Woodson



GM 60-2057
Fig. WO 3
Woodson



GM 60-2058
Fig. L2
Ladmore



GM 60-2059
Fig. L3
Ladmore

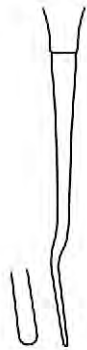

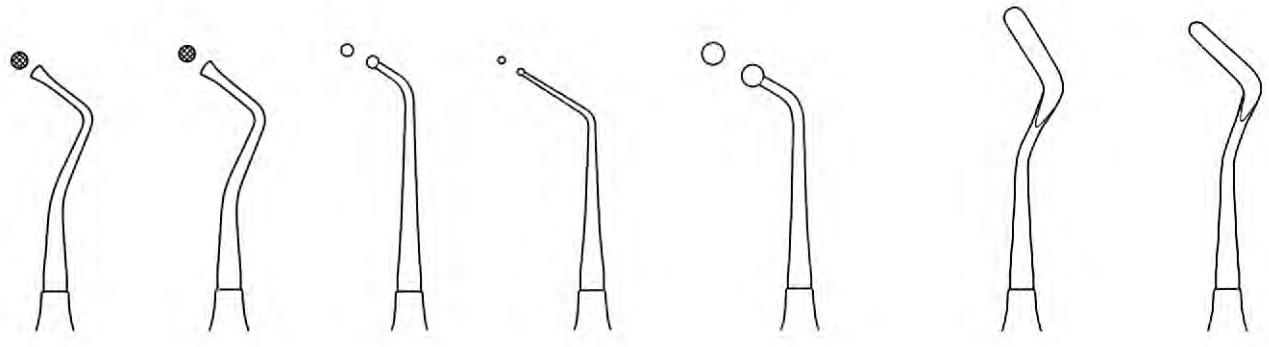

GM 60-2060
 Fig. 1
 Ward

GM 60-2061
 Fig. 2
 Ward

GM 60-2062
 Fig. 7A

GM 60-2063
 Fig. 19

GM 60-2064
 Fig. 7B

GM 60-2065
 Fig. 6

GM 60-2066
 Fig. 11

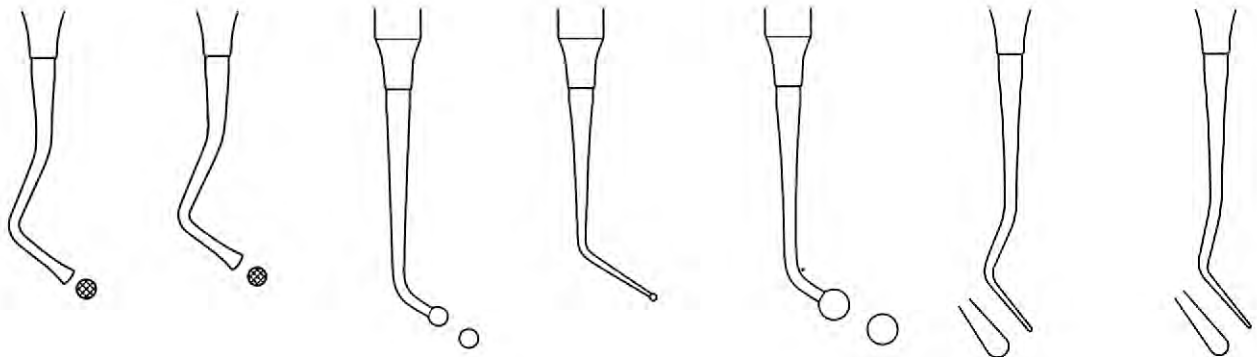

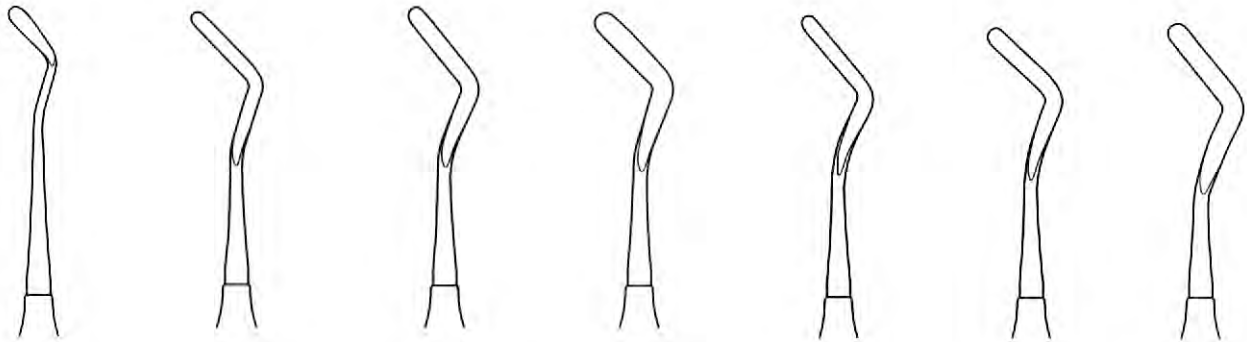

GM 60-2067
Fig. 179

GM 60-2068
Fig. 1
2 mm

GM 60-2069
Fig. 2
2.5 mm

GM 60-2070
Fig. 3
3 mm

GM 60-2071
Fig. 11

GM 60-2072
Fig. 12

GM 60-2073
Fig. 13

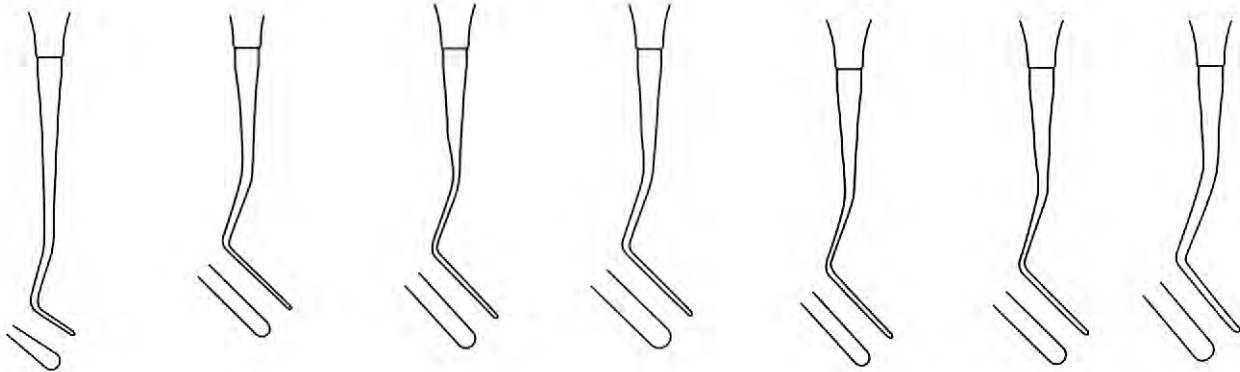

61

- EN** Gingivectomy Knives
- DE** Gingivektomie Messer
- ES** Cuchillos de gingivectomía

Page 106 to 107



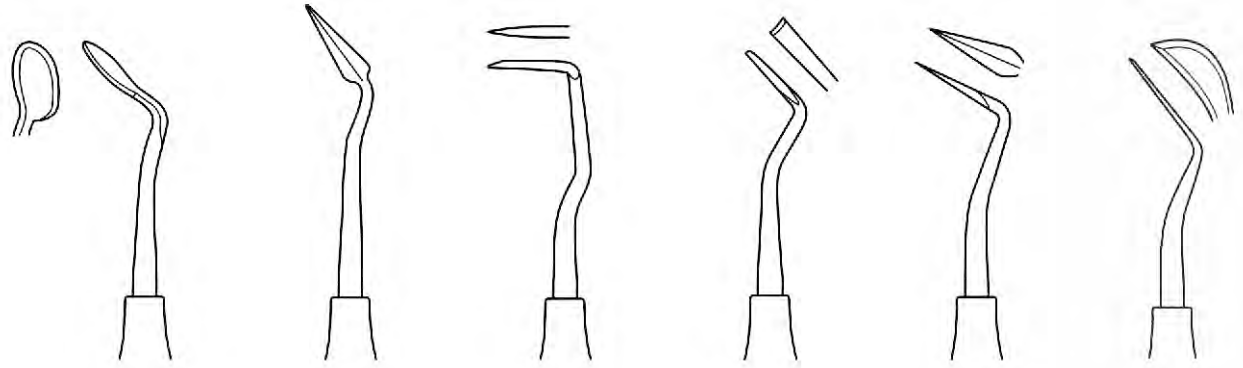

GM 61-2101
Goldman-Fox
Fig. 7

GM 61-2102
Goldman-Fox
Fig. 8

GM 61-2103
Goldman-Fox
Fig. 9

GM 61-2104
Goldman-Fox
Fig. 10

GM 61-21
Goldman-Fi
Fig. 11

GM 61-2106
Kirkland
Fig. 15K/16K

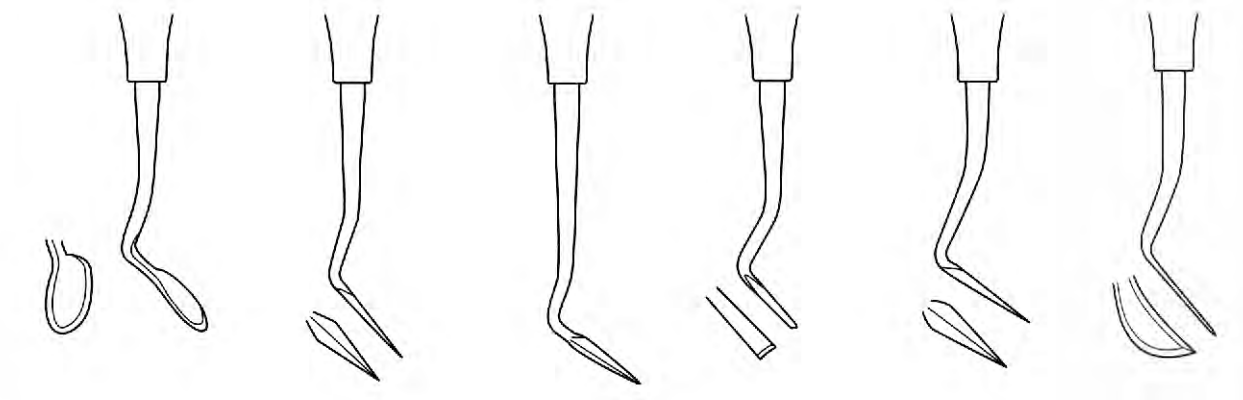

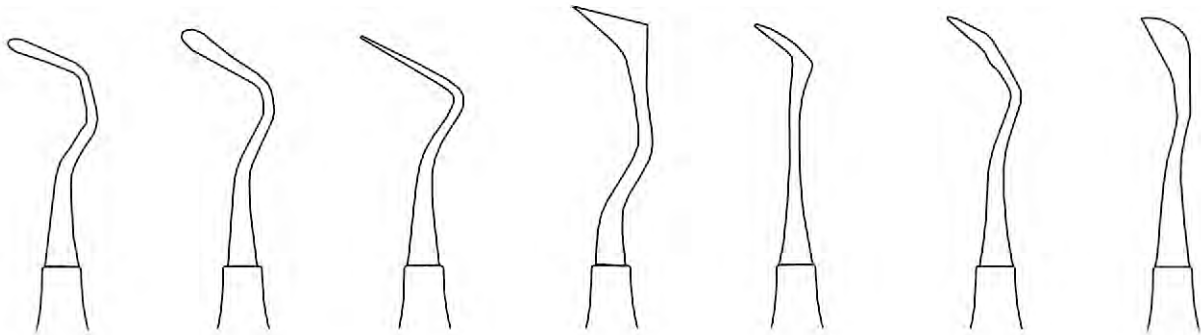

GM 61-2107	GM 61-2108	GM 61-2109	GM 61-2110	GM 61-2111	GM 61-2112	GM 61-2113
Fig. 1	Fig. 2	Fig. 1/2	Fig. 19/20	Fig. CK-3	Fig. CK-6	Fig. 1/2
Reddy Thin	Reddy Thin	Sanders	USC Towner	Crane Kaplan	Crane Kaplan	Solt

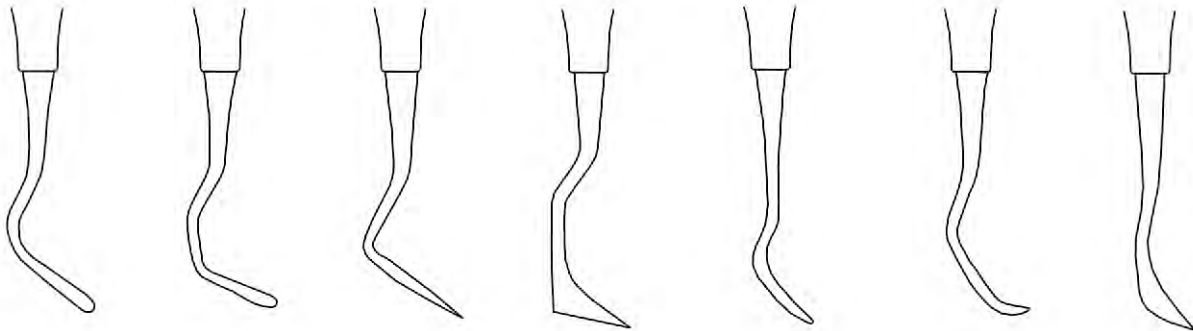

62

- EN** Cement Spatulas
- DE** Zementspatel
- ES** Espátulas de cemento

Page 106 to 107

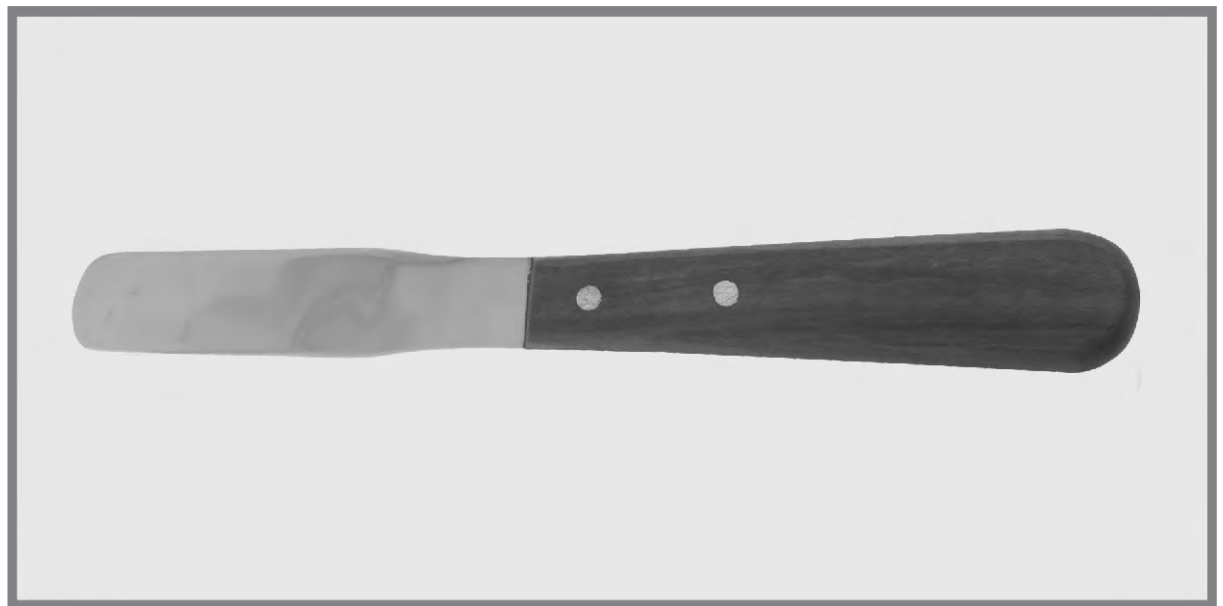



GM 62-2151
 Fig. 26
 Dista

GM 62-2152
 Fig. 27
 Mesial

GM 62-2153
 Fig. 29
 Mesial

GM 62-2154
 Fig. 29
 Mesial

GM 62-2155
 Fig. 77/78
 Distal

GM 62-2156
 Mesial
 54-1142-00

GM 62-2157
 Fig. 28
 Distal

Wooden Handle



GM 62-2158
 Fig. 28
 Distal



GM 62-2159
 Fig. 28
 Distal



GM 62-2160
 Fig. 28
 Distal



GM 62-2161
 Fig. 28
 Distal



GM 62-21GM 62
 Fig. 28
 Distal





GM 62-2163
Fig. 1



Fig. 2



Fig. 3



Fig. 4



Fig. 5



Fig. 1



Fig. 2
GM 62-2164



Fig. 3

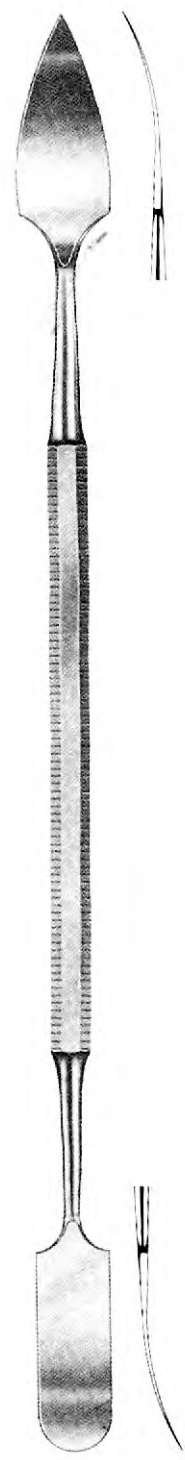

GM 62-2165
Fig. 31
Gritman



GM 62-2166
Fig. 1

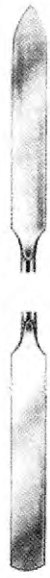

Fig. 2



Fig. 3



GM 62-2167
Fig. 1



Fig. 2



Fig. 5



Fig. 3



Fig. 6



Fig. 4



Fig. 7





GM 62-2168
Fig. 1



Fig. 2



Fig. 4



Fig. 5



GM 62-2169
Fig. 313



Fig. 322



Fig. 324



GM 62-2170



Fig. 6



Fig. 7



Fig. 8



Fig. 24 A



Fig. 25 E



Fig. 11



Fig. 12



Fig. 5

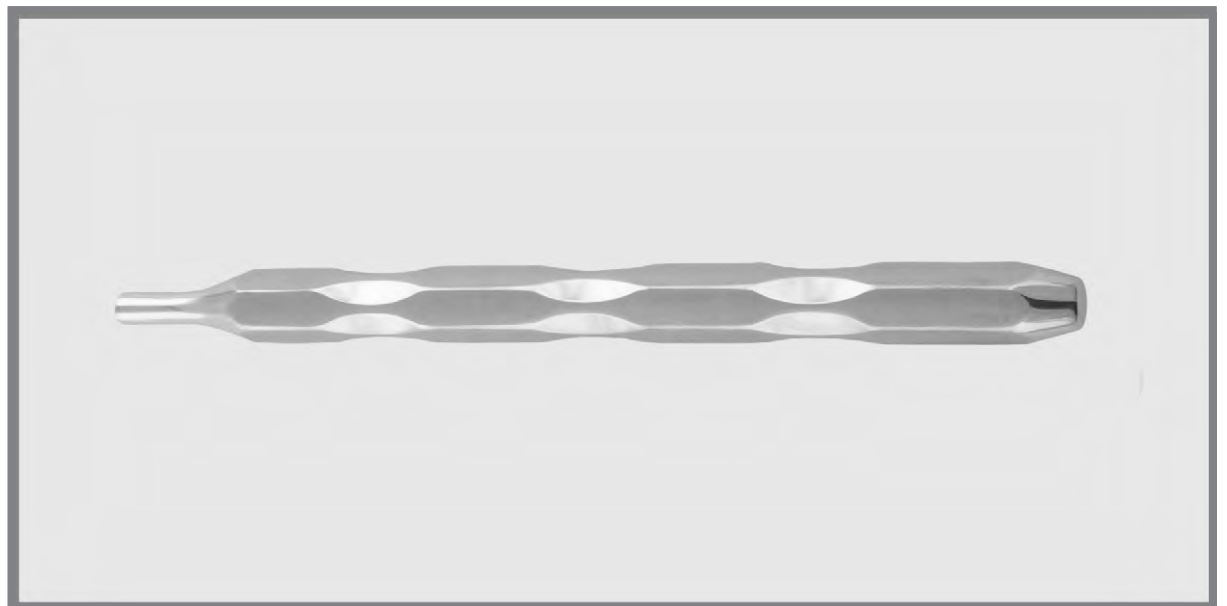

Fig. 8

63

- EN** Mouth Mirrors
- DE** Mundspiegel
- ES** Espejos bucales

Page 113 to 115



Simple Stem



Plain
Magnifying
Front Surface

1 = 16 mm GM 63-2301-16
 3 = 20 mm GM 63-2301-20
 4 = 22 mm GM 63-2301-22
 5 = 24 mm GM 63-2301-24



Plain
Magnifying
Front Surface

4 = 22 mm
 5 = 24 mm



Plain
Magnifying
Front Surface

GM 63-2302-22 3 = 20 mm GM 63-2303-20
 GM 63-2302-24 4 = 22 mm GM 63-2303-22
 5 = 24 mm GM 63-2303-24

Cone Socket



Plain
Magnifying
Front Surface

3 = 20 mm GM 63-2304-20
 4 = 22 mm GM 63-2304-22
 5 = 24 mm GM 63-2304-24



Plain
Magnifying
Front Surface

3 = 20 mm GM 63-2305-20
 4 = 22 mm GM 63-2305-22
 5 = 24 mm GM 63-2305-24





GM 63-2306-01
 4,5 cm/13/4



GM 63-2306-02
 Handle only

HILGER
 GM 63-2306-00
 18 cm/7"



GM 63-2307-14
 Hollow



GM 63-2308-14
 Hollow



GM 63-2309-14
 Hollow



GM 63-2310-14
 Hollow



Mirror handles are available with Cone Socket and Simple Stem Fittings
 Matric / US Threads, Please specify while ordering



GM 63-2311-12
Hollow



GM 63-2312-12
Solid



GM 63-2313-12
Solid



GM 63-2314-12
Solid



GM 63-2315-00
Solid



GM 63-2316-00
Hollow

Mirror handles are available with Cone Socket and Simple Stem Fittings
 Matric / US Threads, Please specify while ordering

64

- EN** Amalgam Instruments
- DE** Amalgam Instrumente
- ES** Instrumentos de amalgama

Page 116 to 117

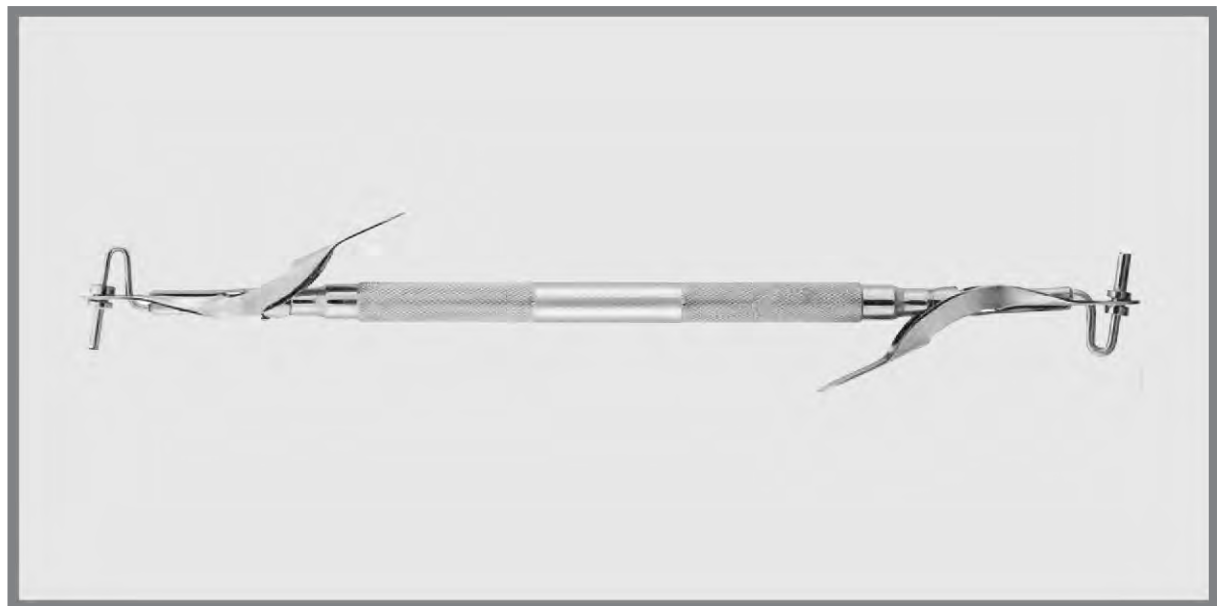

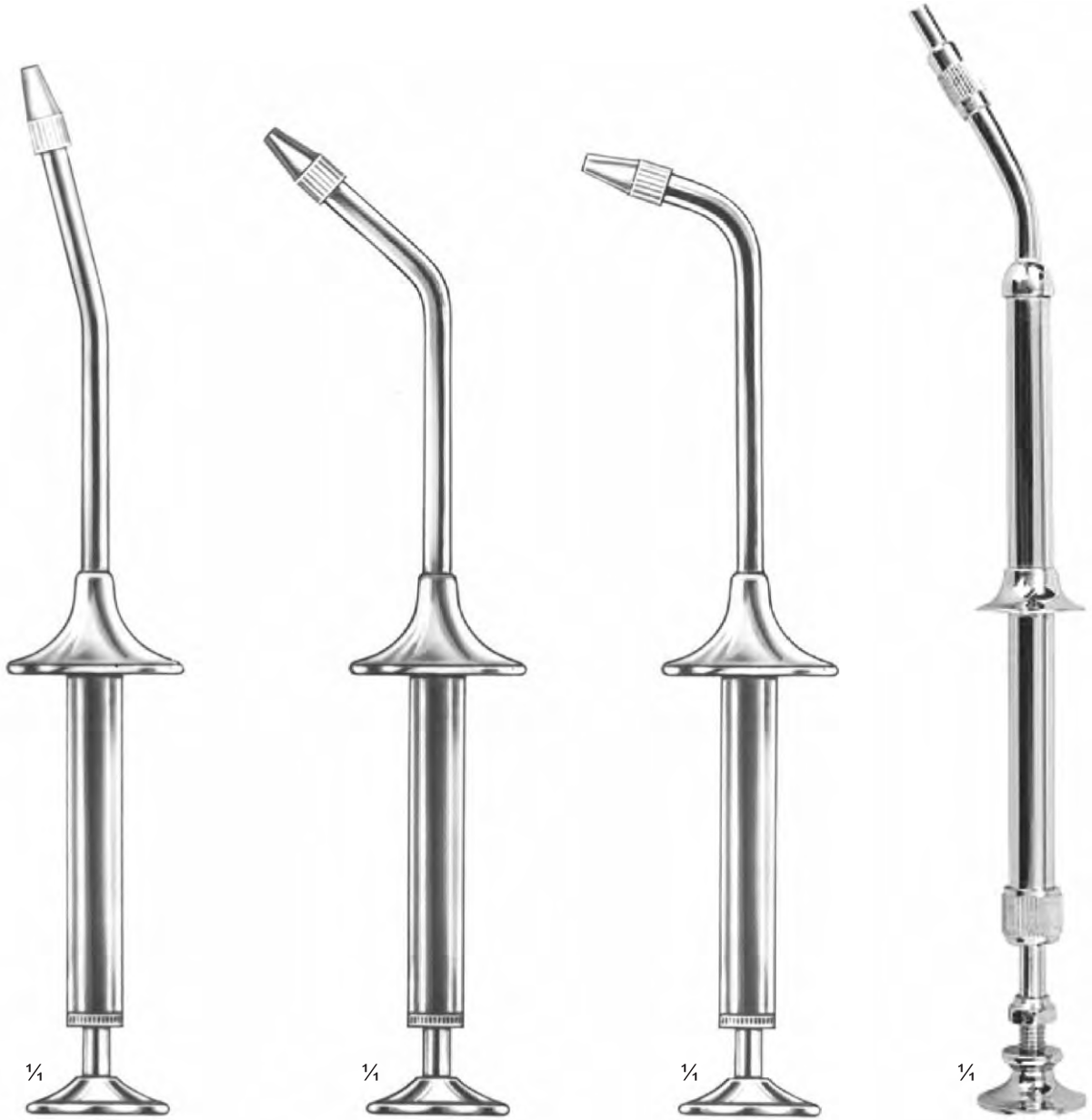

with metal tip GM 64-2351
 with plastic tip GM 64-2352

GM 64-2353
 GM 64-2354

GM 64-2355
 GM 64-2356

GM 64-2357
 GM 64-2358

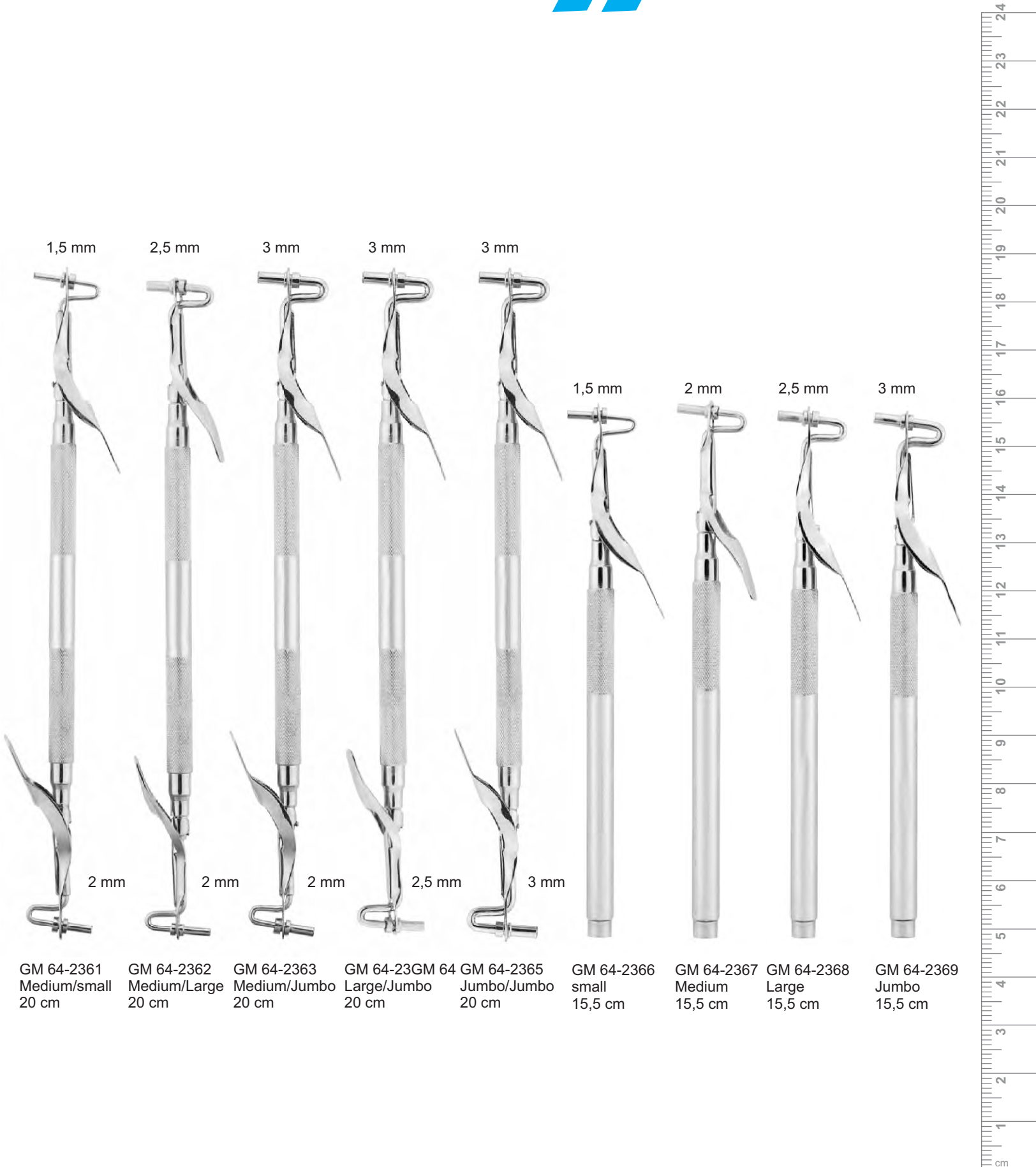

1,5 mm

2,5 mm

3 mm

3 mm

3 mm

1,5 mm

2 mm

2,5 mm

3 mm

2 mm

2 mm

2 mm

2,5 mm

3 mm

GM 64-2361
 Medium/small
 20 cm

GM 64-2362
 Medium/Large
 20 cm

GM 64-2363
 Medium/Jumbo
 20 cm

GM 64-2364
 Large/Jumbo
 20 cm

GM 64-2365
 Jumbo/Jumbo
 20 cm

GM 64-2366
 small
 15,5 cm

GM 64-2367
 Medium
 15,5 cm

GM 64-2368
 Large
 15,5 cm

GM 64-2369
 Jumbo
 15,5 cm

65

- EN** Matrix Retainers
- DE** Matrix-Halterungen
- ES** Retenedores de matrices

Page 118 to 125

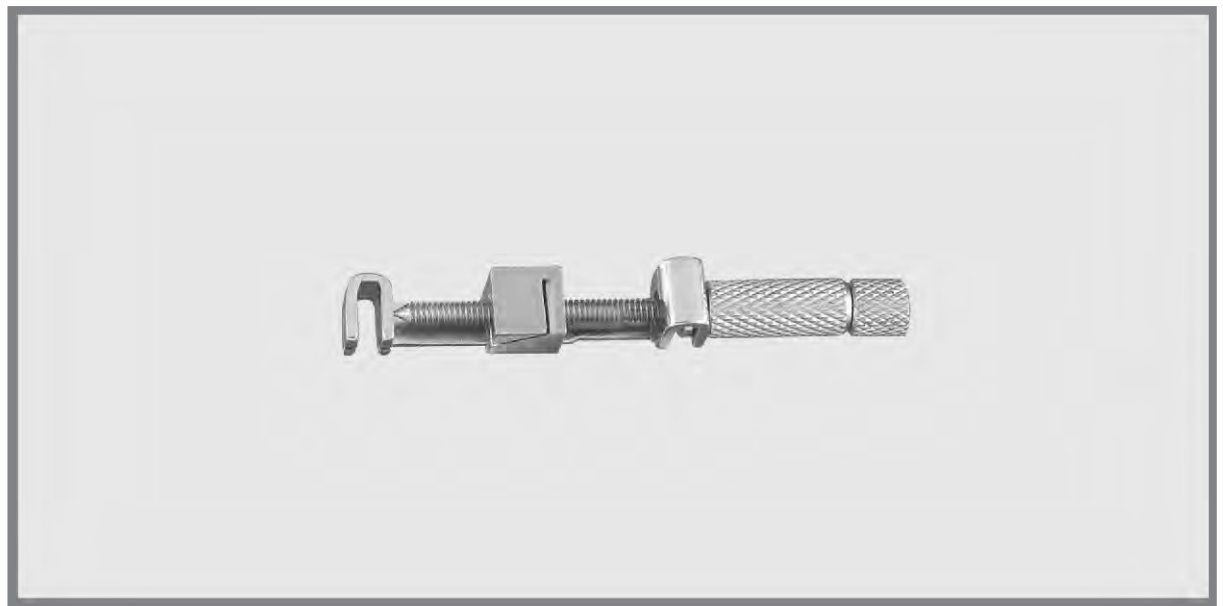



¼

Tof·emire-Universal
GM 65-2601



¼

Tof·emire-Senior
GM 65-2602



¼

Tof·emire-Junior
GM 65-2603



¼

Fig.1
Nystrom
left
GM 65-2604



¼

Fig.2
Nystrom
right
GM 65-2605



¼

Ivory 8
GM 65-2606 5 mm
GM 65-2607 6 mm
GM 65-2608 7 mm



¼

Ivory 8N
GM 65-2609



adjustable

¼

Didner 8P
GM 65-2610



Ivory
 GM 65-2611
 Fig. 1

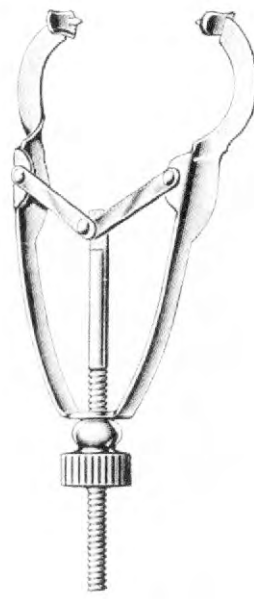

Ivory
 GM 65-2612
 Fig. 12



Ivory
 GM 65-2613
 Fig. 12A





Ainsworth
 GM 65-2614
 16 cm / 6 Ć'



Ainsworth
 GM 65-2615
 16 cm / 6 Ć'



Ivory
 GM 65-2616
 15 cm / 6'



Ivory
 GM 65-2617
 15 cm / 6'



Ivory
 GM 65-2618
 17 cm / 6 ĩ'



Brewer
 GM 65-2619
 17 cm / 6 ĩ'





Stockes
 GM 65-2620
 17 cm / 6 1/2"

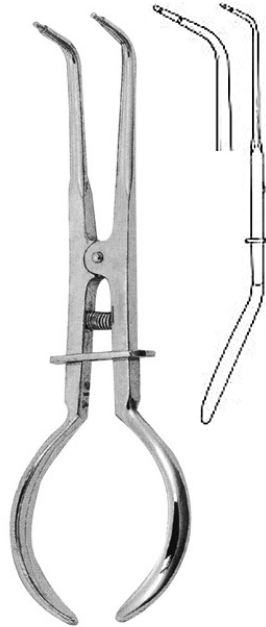

Stockes
 GM 65-2621
 17 cm / 6 1/2"



Palmer
 GM 65-2622
 17 cm / 6 1/2"



White
 GM 65-2623
 17 cm / 6 1/2"



Band Pusher-Mershon
 GM 65-2624
 14 cm / 5 1/2"





GM 65-2626
Fig. 00
Anterior Teeth



GM 65-2627
Fig. 0
Premolars



GM 65-2628
Fig. 1
Premolars



GM 65-2629
Fig. 1A
Premolars



GM 65-2630
Fig. 2
Premolars



GM 65-2631
Fig. 2A
Premolars



GM 65-2632
Fig. 2AS
Premolars



GM 65-2633
Fig. 3
Lower Molars



GM 65-2634
Fig. 4
Upper Molars



GM 65-2635
Fig. 5
Upper Molars



GM 65-2636
Fig. 6
Anterior Teeth



GM 65-2637
Fig. 7
Lower Molars



GM 65-2638
Fig. 7A
Lower Molars



GM 65-2639
Fig. 8
Upper Molars



GM 65-2640
Fig. 8A
Molars General



GM 65-2641
Fig. 9
Anterior Teeth



GM 65-2642
Fig. 9S
Anterior Teeth



GM 65-2643
Fig. 10
Molars General



GM 65-2644
Fig. 11
Molars General



GM 65-2645
Fig. 24
Molars General



GM 65-2646
Fig. 25
Molars General



GM 65-2647
Fig. 26
Lower Molars



GM 65-2648
Fig. 26N
Molars General



GM 65-2649
Fig. 27
Molars General



GM 65-2GM 650
 Fig. 27N
 Premolars



GM 65-2GM 651
 Fig. 28
 Lower Molars



GM 65-2GM 652
 Fig. 29
 Lower Molars



GM 65-2GM 653
 Fig. 30
 Upper Molars



GM 65-2GM 654
 Fig. 31
 Upper Molars



GM 65-2GM 655
 Fig. 56
 Molars General



GM 65-2GM 656
 Fig. 56S
 Molars General



GM 65-2GM 657
 Fig. 201
 Upper Molars



GM 65-2GM 658
 Fig. 205
 Upper Molars



GM 65-2GM 659
 Fig. 212
 Anterior Teeth



GM 65-2660
 Fig. 212SA
 Anterior Teeth



GM 65-2661
 Fig. W2
 Premolars



GM 65-2662
 Fig. W3
 Lower Molars



GM 65-2663
 Fig. W4
 Upper Molars



GM 65-2664
 Fig. W7
 Lower Molars



GM 65-26GM 65 Frame - Child
 13 cm/5"
 GM 65-2666 Frame - Adult
 15 cm/6"





GM 65-2667
Beerendonk

GM 65-2668
Boley



Iwanson
 One side graugation
 GM 65-2669 Metal
 GM 65-2670 Wax

Double side graugation
 GM 65-2671 Metal
 GM 65-2672 Wax



66

- EN** Hemostatic Forceps
- DE** Arterienklemmen
- ES** Pincas hemostaticas

Page 126 to 132





Halsted-Mosquito



GM 66-2701
12.5 cm/5'



GM 66-2702
14.5 cm/5 Ĩ'



GM 66-2703
14 cm/5 Ğ'



GM 66-2704
12.5 cm/5'
1:2



GM 66-2705
14.5 cm/5 Ĩ'
1:2



GM 66-2706
12 cm/4 Ĩ'
1:2



GM 66-2707
14 cm/4 Ğ'
1:2



Micro-Mosquito



GM 66-2708
10 cm/4'



GM 66-2709
12 cm/4 Ĩ'



GM 66-2710
9.5 cm/3 Ğ'



GM 66-2711
11.5 cm/4 Ğ'



GM 66-2712
10 cm/4'
1:2



GM 66-2713
12 cm/4 Ĩ'
1:2



GM 66-2714
10 cm/4'
1:2



GM 66-2715
12 cm/4 Ĩ'
1:2



Halsted-Mosquito

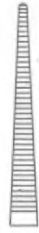

GM 66-2716
18 cm/7'



GM 66-2717
18 cm/7'



GM 66-2718
18 cm/7'
1:2



GM 66-2719
18 cm/7'
1:2



Leriche



GM 66-2720
15 cm/6'



GM 66-2721
15 cm/6'



GM 66-2722
15 cm/6'
1:2



GM 66-2723
15 cm/6'
1:2

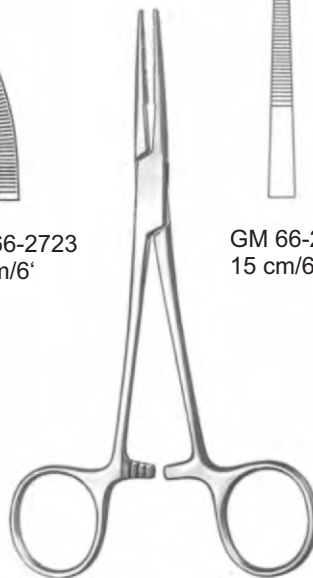

Kelly



GM 66-2724
15 cm/6'



GM 66-2725
15 cm/6'



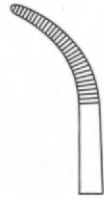
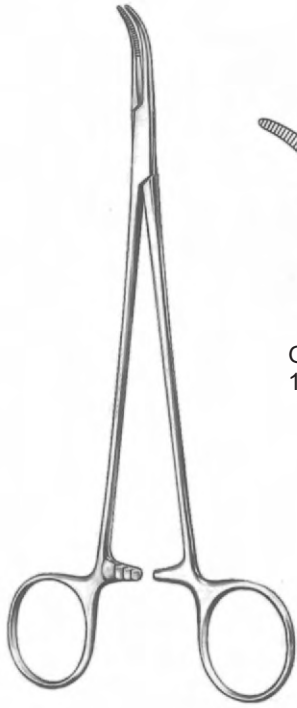

GM 66-2726
18.5 cm/7 ğ'

Mixer-Baby

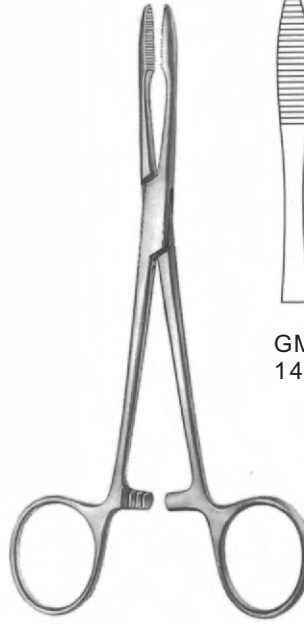

GM 66-2727 14.5 cm/5 ĺ'
 GM 66-2728 16 cm/6 ğ'

Pean



GM 66-2729 13 cm/5'
 GM 66-2730 14 cm/5 Ğ'
 GM 66-2731 17 cm/6 ĺ'
 GM 66-2732 13 cm/5'
 GM 66-2733 14 cm/5 Ğ'
 GM 66-2734 17 cm/6 ĺ'

Pean

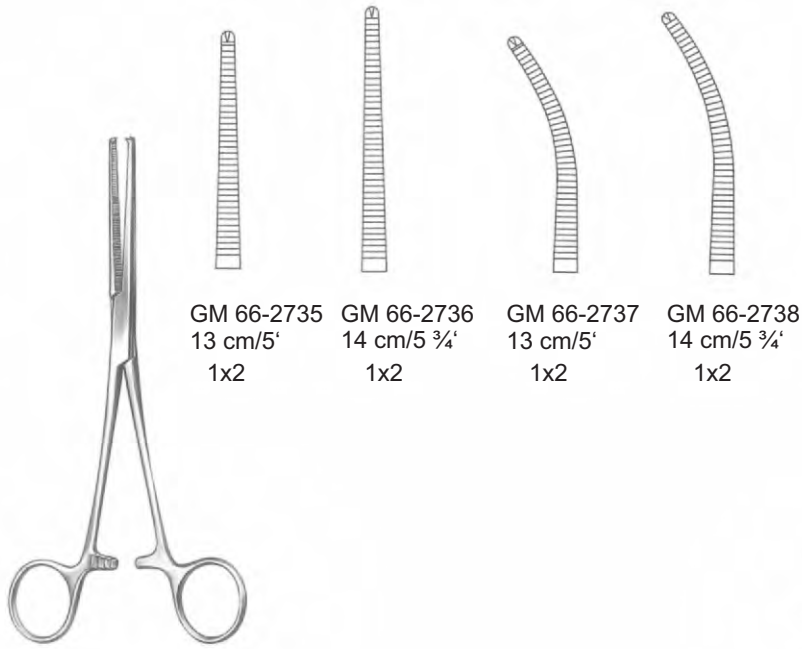

GM 66-2735 13 cm/5' 1x2
 GM 66-2736 14 cm/5 3/4' 1x2
 GM 66-2737 13 cm/5' 1x2
 GM 66-2738 14 cm/5 3/4' 1x2

Kocher

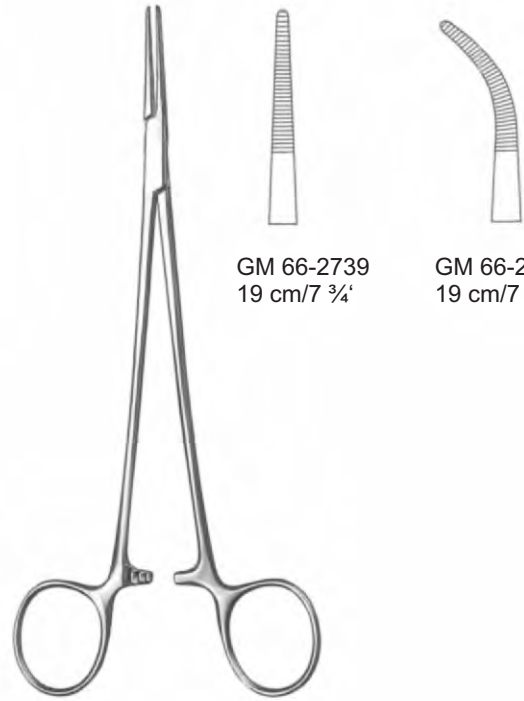

GM 66-2739 19 cm/7 3/4'
 GM 66-2740 19 cm/7 3/4'

Adson

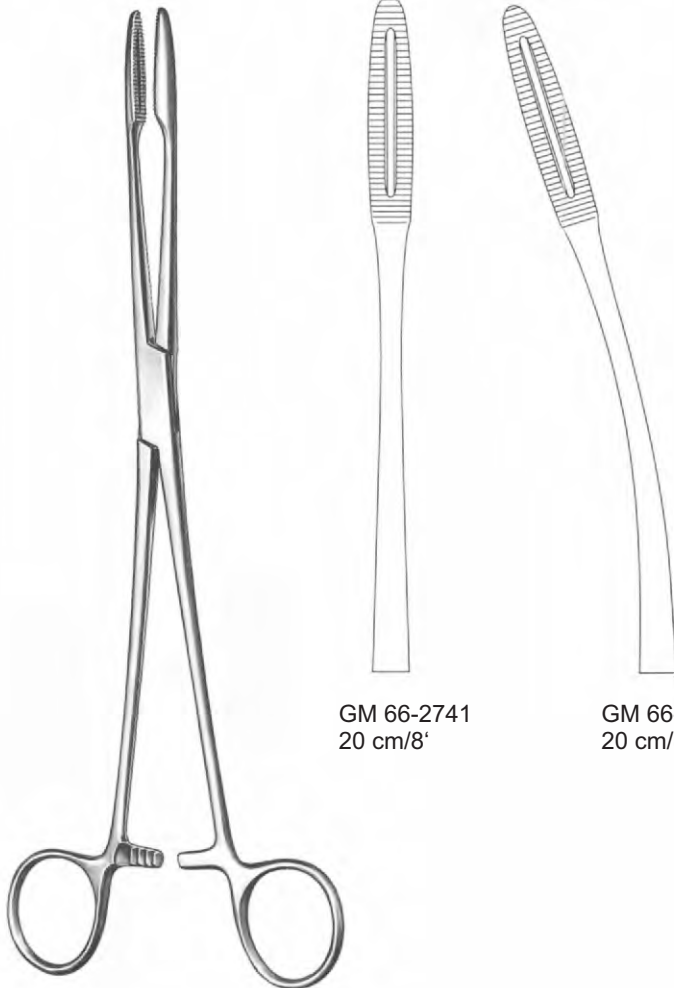

GM 66-2741 20 cm/8'
 GM 66-2742 20 cm/8'

Gross-Maier



GM 66-2743 12.5 cm/5'
 GM 66-2744 12.5 cm/5'

DeBakey-Mosquito





Babcock

GM 66-2745 16 cm/6 ğ
 GM 66-2746 18 cm/7 K
 GM 66-2747 20 cm/7 N
 GM 66-2748 24 cm/9 Ğ



Babcock

GM 66-2749 TC
 16 cm/6 Ğ

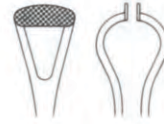

ATRAUMA



BABCOCK
 GM 66-2750
 16 cm/9 ğ

ATRAUMA

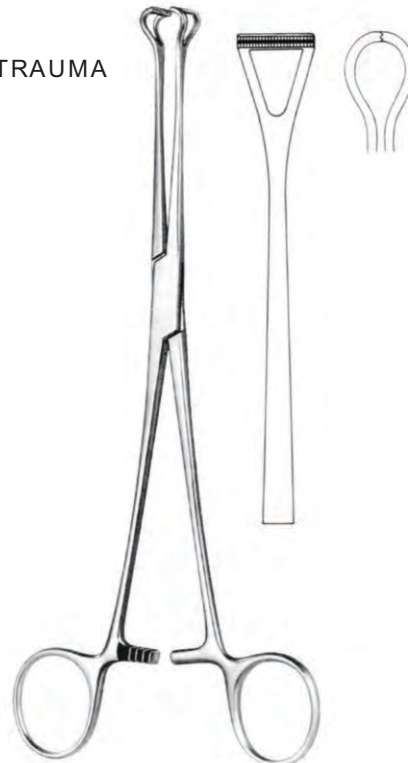

BABCOCK
 GM 66-2751
 20.5 cm/8 K'





Allis

GM 66-2752
 15.5 cm/6"
 4:5



GM 66-2753
 15.5 cm/6"
 5:6



GM 66-2754
 19 cm/7 1/2"
 5:6



Allis-Baby

GM 66-2755
 12 cm/5"
 4:5



ATRAUMA



GM 66-2756 GM 66-2757
16 cm/6 3/4" 20 cm/8"

Allis

67

- EN** Towel Clamps
- DE** Handtuchklammern
- ES** Abrazaderas de toalla

Page 133 to 134

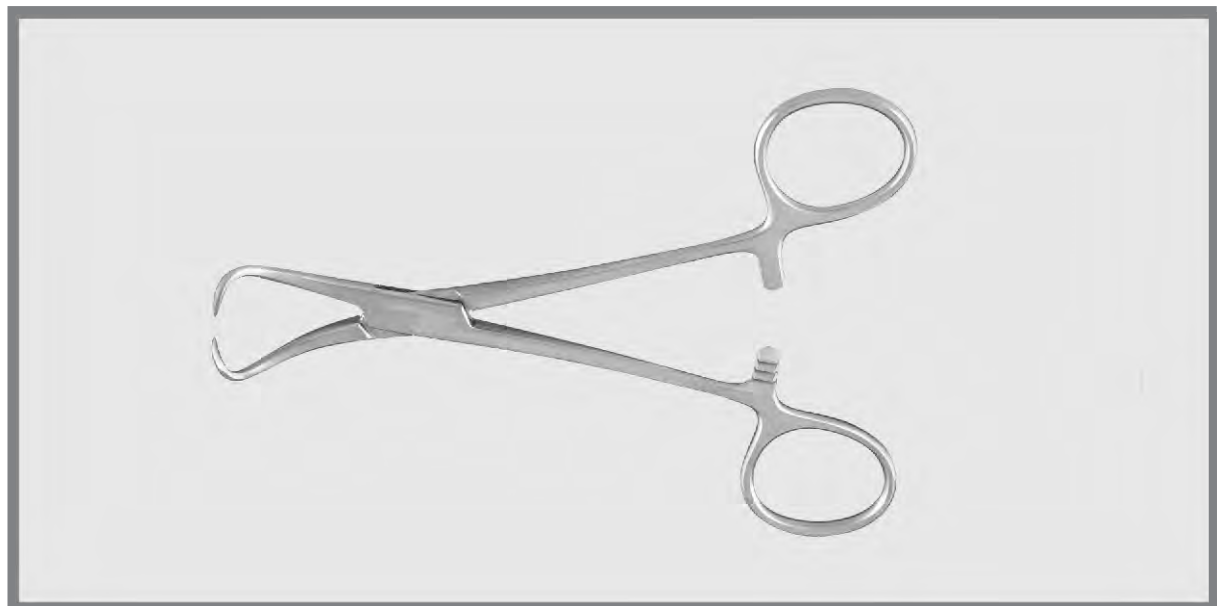

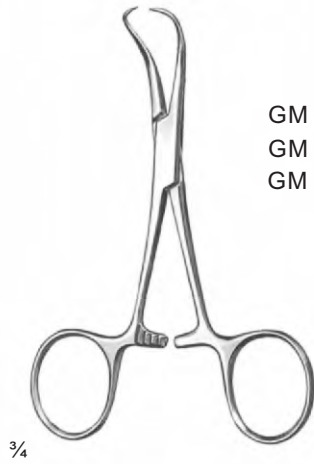

¾

Backhaus

GM 67-2801 9 cm/3 Ğ'
 GM 67-2802 11.5 cm/4 Ğ'
 GM 67-2803 13 cm/5'



¾

for paper clothes

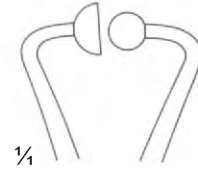

¼

GM 67-2804
 11.5 cm/4 Ğ'

GM 67-2805
 14 cm/5 Ğ'

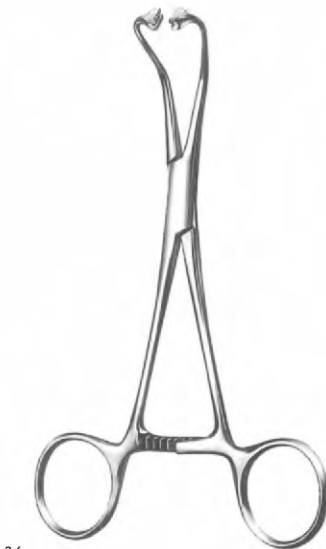

¾

Peers-Bertram
 GM 67-2806
 14.5 cm/5 Ğ'

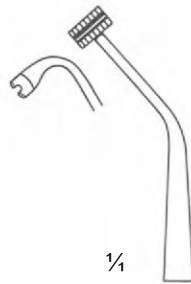

¼

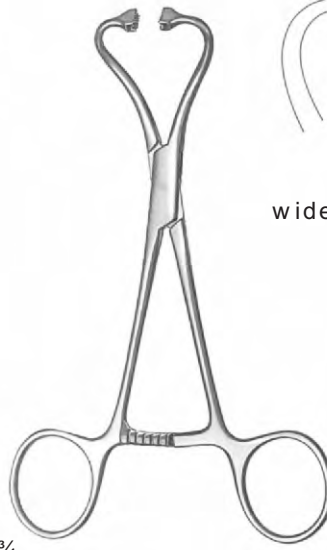

¾

Peers-Bertram modif.
 GM 67-2807
 15.5 cm/6'

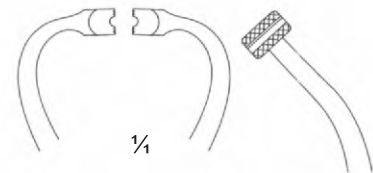

¼

wide jaw for tube fixation



¾

Tohoku



¼

GM 67-2808
 10.5 cm/4"

GM 67-2809
 13.5 cm/5 ½"



¾

Schadel
 GM 67-2810
 8.5 cm/3 ⅓"
 sharp



¾

Jones
 sharp

GM 67-2811
 8.5 cm/3 ⅓"



68

- EN** Needle Holders
- DE** Nadelhalter
- ES** Porte-aguilles

Page 135 to 143





1/4
smooth

Webster
GM 68-2901
13 cm/5 K'

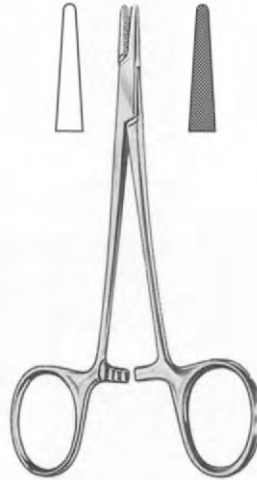

Halsey

GM 68-2902 13 cm/5 K Plain
GM 68-2903 13 cm/5 K Serrated



1/4

Derf
GM 68-2904
12 cm/4 I'
one fenestrated jaw



Crile-Wood
GM 68-2905
15 cm/5 N'



Crile-Murray
GM 68-2906
15 cm/5 N'
slender pattern

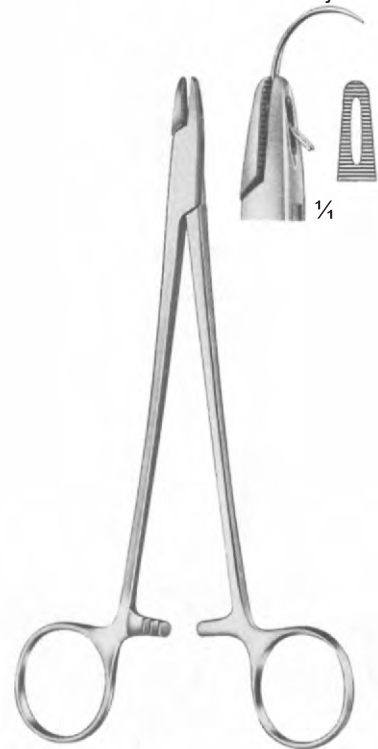

Adson
GM 68-2907
18 cm/7 K"
one fenestrated jaw

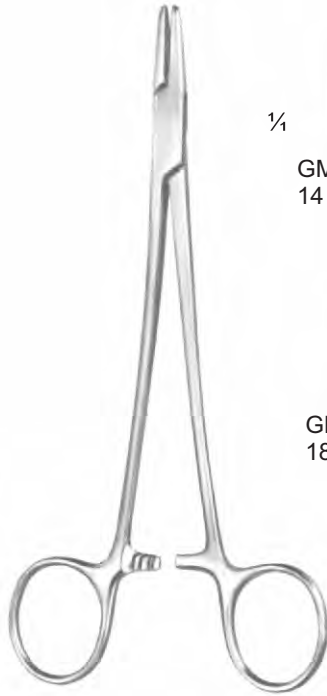

MAYO-HEGAR

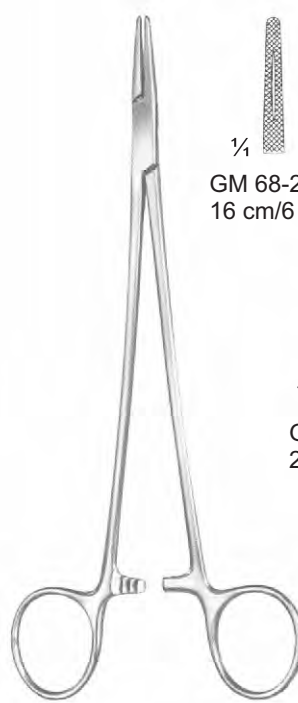
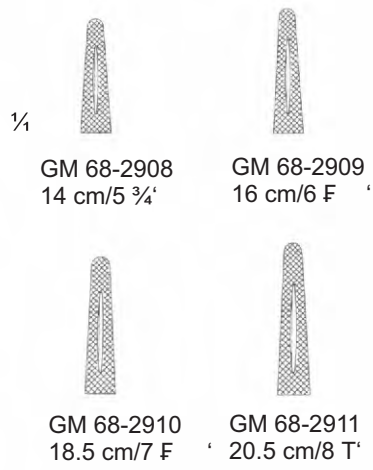

MAYO-HEGAR slender pattern

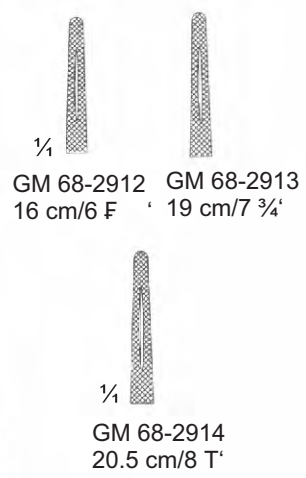

HEGAR-BAUMGARTNER
 GM 68-2915
 14 cm/5 3/4'



MATHIEU

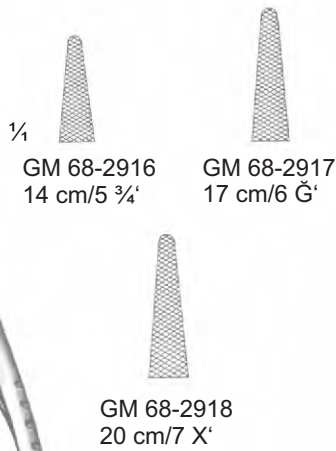

MATHIEU slender pattern

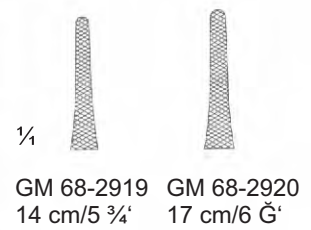



Lichtenberg
 GM 68-2921
 20 cm/7 N'



Toennis
 GM 68-2922
 18.5 cm/7 ğ'



Crile
 GM 68-2923
 15 cm/5 N'

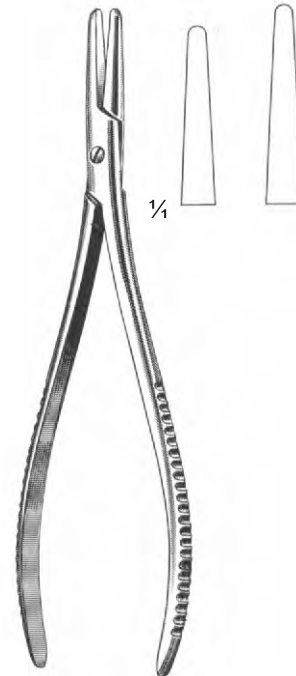

Langenbeck
 GM 68-2924 16 cm/6 ğ
 GM 68-2925 20 cm/7 N'

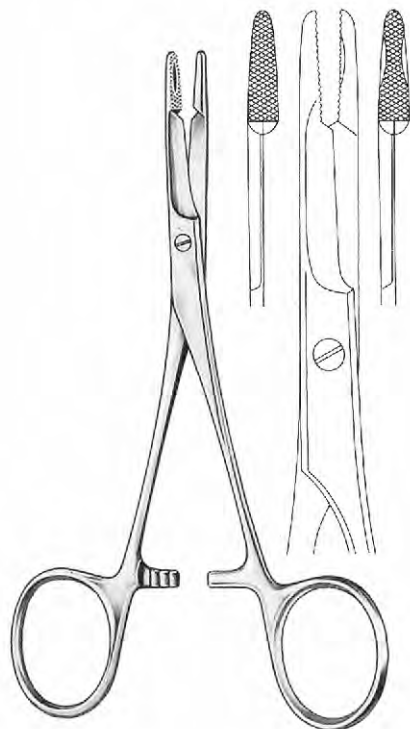

Olsen-Hegar

GM 68-2926 11 cm/4 Λ'
 GM 68-2927 14 cm/5 Ğ'
 GM 68-2928 18 cm/7 K'
 GM 68-2929 19 cm/7 Ğ'

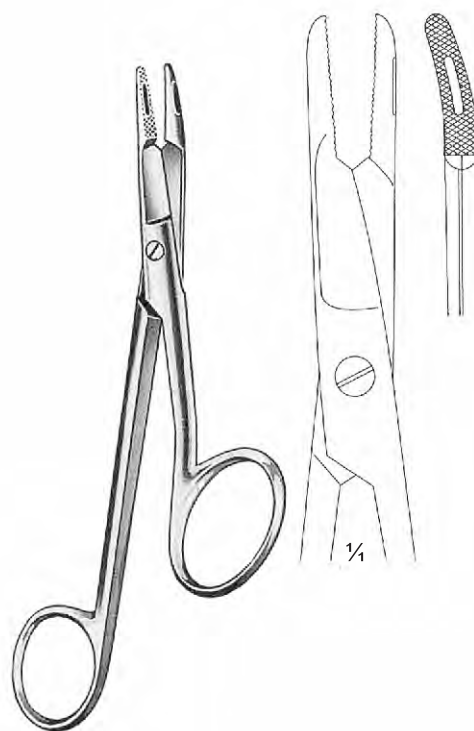

Gillies

GM 68-2930 Right hand
 GM 68-2931 Left hand
 16 cm/6 ğ'





HALSEY



GM 68-2932
 13 cm/5 K
 smooth jaw



GM 68-2933
 13 cm/5 K
 0.4 mm



WEBSTER
 12.5 cm/4 N'

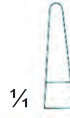

GM 68-2934
 smooth jaw



GM 68-2935
 0.4 mm



DERF
 GM 68-2936
 12 cm/4 I'



0.4 mm



Toennis
 GM 68-2937
 18 cm/7 K'



0.5 mm



Langenbeck



0.5 mm
 GM 68-2938
 18.5 cm/7 g'



0.5 mm
 GM 68-2939
 20.5 cm/8 K'



0.5 mm
 GM 68-2940
 23 cm/9'



3/4

Mayo-Hegar
standard profile

1/4

GM 68-2941
16 cm/6 F
0.5 mm

GM 68-2942
18 cm/7"
0.5 mm

GM 68-2943
20 cm/8"
0.5 mm



3/4

Debaquey
mini profile

1/4

GM 68-2944
18 cm/7"
0.4 mm

GM 68-2945
20 cm/8"
0.4 mm



3/4

HEGAR-BAUMGARTNER

1/4

GM 68-2946
13 cm/5 T'
0.4 mm



GM 68-2947
14 cm/5 3/4'
0.4 mm



3/4

Mathieu
Standard Profile

1/4

GM 68-2948
14 cm/5 3/4'
0.5 mm



GM 68-2949
17 cm/6 C'
0.5 mm



GM 68-2950
20 cm/8'
0.5 mm



3/4

Mathieu
Standard Profile

1/4

GM 68-2951
14 cm/5 3/4'
0.5 mm



GM 68-2952
17 cm/6 C'
0.5 mm

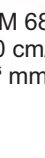

GM 68-2953
20 cm/8'
0.5 mm





Mathieu



GM 68-2954
 17 cm/6 3/4"
 0.5 mm



GM 68-2955
 20 cm/8"
 0.5 mm



GM 68-2956
 23 cm/9"
 0.5 mm

with interior ratchet
 standard profile



Lichtenberg
 GM 68-2957
 20 cm/7 7/8"



0.5 mm



Zweifel



GM 68-2958
 20.5 cm/8 1/8"
 0.5 mm



GM 68-2959
 23 cm/9"
 0.5 mm

with hinged rehet
 Standard Profile

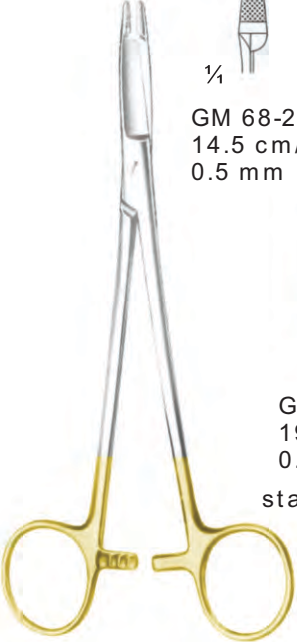

$\frac{1}{4}$
 GM 68-2960 14.5 cm/5 ½" 0.5 mm
 GM 68-2961 17 cm/6 ¾" 0.5 mm
 GM 68-2962 19 cm/9" 0.5 mm
 standard profile
 $\frac{3}{4}$
 Olsen-Hegar



$\frac{1}{4}$
 GM 68-2963 16 cm/6 ⅔" 0.5 mm
 standard profile
 Gillies



$\frac{1}{4}$
 GM 68-2964 11 cm/4 ⅜" smooth jaw
 Foster-Gillies



$\frac{1}{4}$
 GM 68-2965 15 cm/6" 0.4 mm
 mini profile
 Gillies-Mini



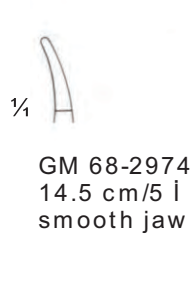
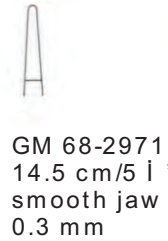
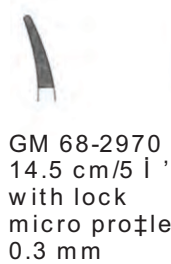

69

- EN** Retractors
- DE** Wundhaken
- ES** Ecarteurs

Page 143 to 148





Fig. 2 = 30 x 10 mm
 Fig. 1 = 26 x 10 mm



Fig. 1 = 30 x 13 mm
 Fig. 2 = 34 x 13 mm

FARABEU
 GM 69-3001
 12 cm/4 3/4"
 Fig. 1 - 2



ROUX
 GM 69-3002

Set complete, Fig. 1- 3

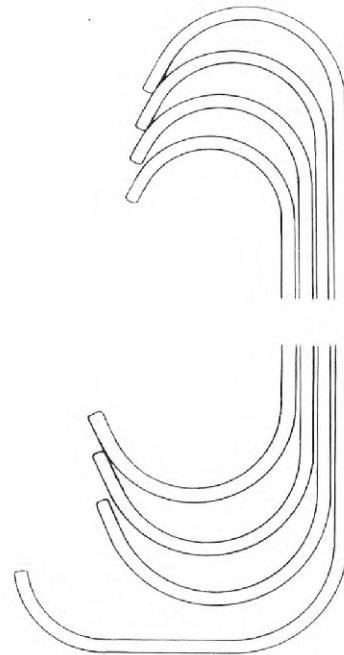
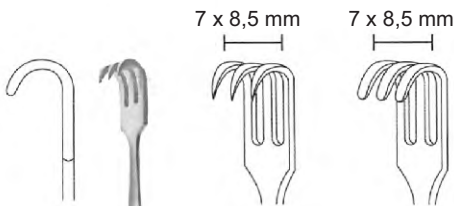

Fig. 1	14 cm/5 1/2"	GM 69-3003	24 x 20 / 30 x 28
Fig. 2	15 cm/6"	GM 69-3004	29 x 26 / 36 x 36
Fig. 3	17 cm/6 3/4"	GM 69-3005	23 x 29 / 38 x 43
Fig. 4	18 cm/7"	GM 69-3006	29 x 24 / 45 x 28



7 x 8,5 mm 7 x 8,5 mm

GM 69-3007 sharp GM 69-3008 blunt

1/2

SENN
 17 cm/6 3/4"

sharp



16 cm/6 1/4"

GM 69-3009

GM 69-3010

GM 69-3011

sharp



16 cm/6 1/4"

GM 69-3012

GM 69-3013

GM 69-3014

GM 69-3015
 18 cm/7"
 Fig. 1

small curvature

GM 69-3016
 18 cm/7"
 Fig. 2

large curvature

1/2

GILLIES
 18 cm/7"

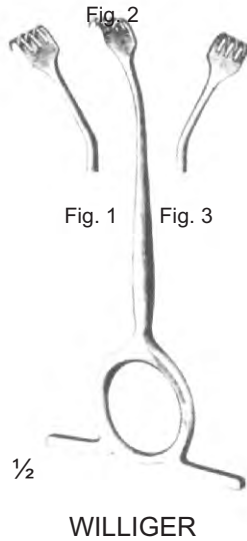
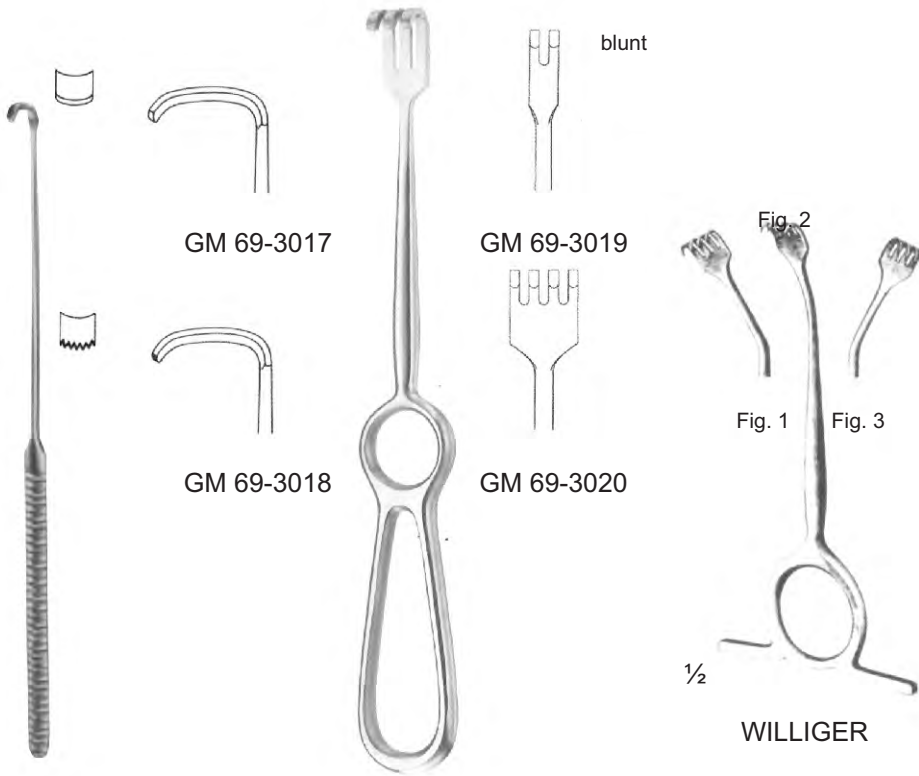
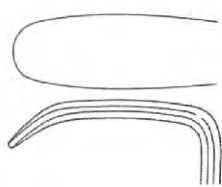

Fig. 1 GM 69-3021 GM 69-3024
 Fig. 2 GM 69-3022 GM 69-3025
 Fig. 3 GM 69-3023 GM 69-3026

STRANDELL-STILLE
 19, cm/7 1/2"

VOLKMANN
 21,5 cm/8 1/2"



GM 69-3027
 30x 11 mm

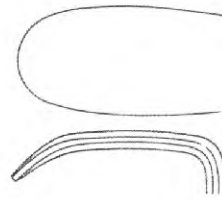

GM 69-3029
 30x 16 mm

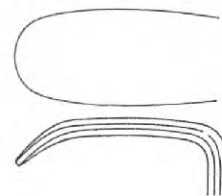

GM 69-3028
 30x 14 mm

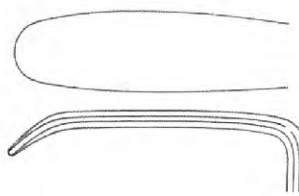

GM 69-3030
 40x 11 mm

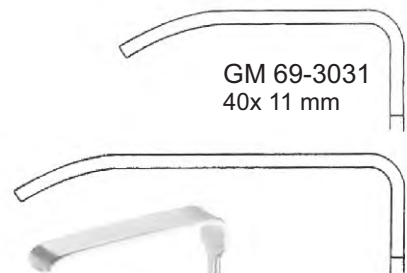

GM 69-3031
 40x 11 mm



GM 69-3032
 55x 11 mm

LANGENBECK
 22 cm/8 3/4"

KOCHER-LANGENBECK
 22 cm/8 1/2"





MIDDELDORPF

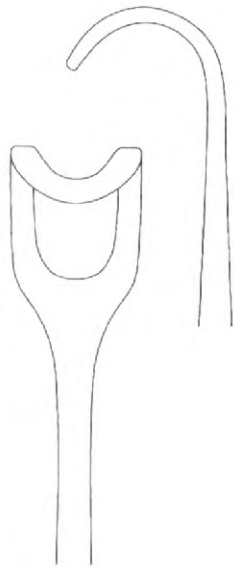

GM 69-3033
 21,5 cm/8 1/2"
 14 x 17 mm

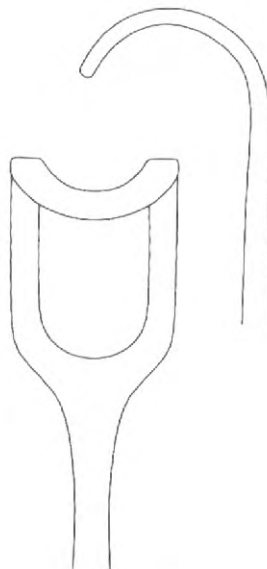

GM 69-3034
 22 cm/8 3/4"
 20 x 22 mm



KOCHER LANGENBECK
 GM 69-3035
 21 cm/8 1/4"
 23 x 8 mm



WARD
 GM 69-3036
 15,5 cm/6"



BOWDLER=HENRY
 GM 69-3037
 16 cm/6 1/4"



KAY (AUSTIN)
 GM 69-3038





16,5 mm

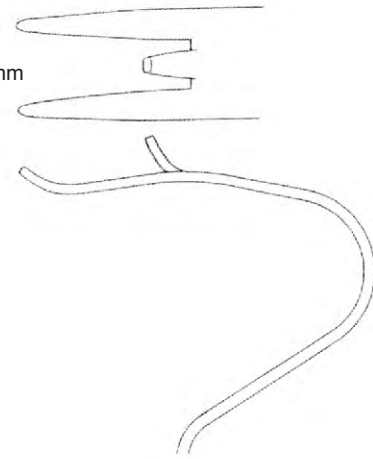

OBWEGESER
 GM 69-3039
 16 cm/6 1/4"

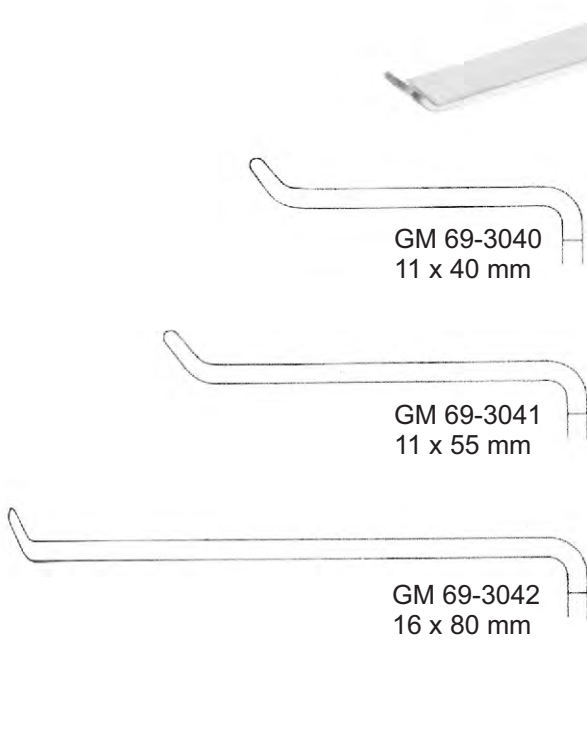

GM 69-3040
 11 x 40 mm

GM 69-3041
 11 x 55 mm

GM 69-3042
 16 x 80 mm



OBWEGESER
 21,5 cm/8 1/2"



OBWEGESER

GM 69-3043
 30 x 9/12 mm

GM 69-3044
 45 x 9/12 mm

GM 69-3045
 60 x 9/12 mm





GM 69-3046
 7 cm/2 3/4"
 sharp



GM 69-3047
 10 cm/4"
 sharp

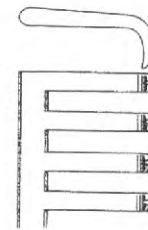
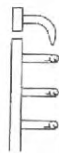

GM 69-3048
 13 cm/4 1/4"
 3 : 4
 sharp

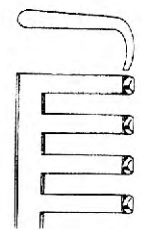

GM 69-3049
 13 cm/4 1/4"
 3 : 4
 blunt

70

- EN** Mouth and Tongue
- DE** Mund und Zunge
- ES** Boca y la lengua

Page 149 to 152





DOYEN-JANSEN (MOLT)
 GM 70-3100 9 cm/3 3/4'
 GM 70-3101 11 cm/4 3/4'
 GM 70-3102 14 cm/5 3/4'



DENHARDT
 GM 70-3103
 12 cm/5'



HEISTER
 GM 70-3104
 13 cm/5 1/4'



ROSER-KOENIG
 16 cm/6 3/4' GM 70-3105
 19 cm/7 3/4' GM 70-3106



JENNINGS
 9 cm/3 3/4' GM 70-3107
 11 cm/4 3/4' GM 70-3108
 13 cm/5' GM 70-3109
 15 cm/6' GM 70-3110

24 x 27 mm



COLLIN
 GM 70-3111
 16 cm/6 3/4'



YOUNG
 GM 70-3112
 16 cm/6 3/4'

GM 70-3113

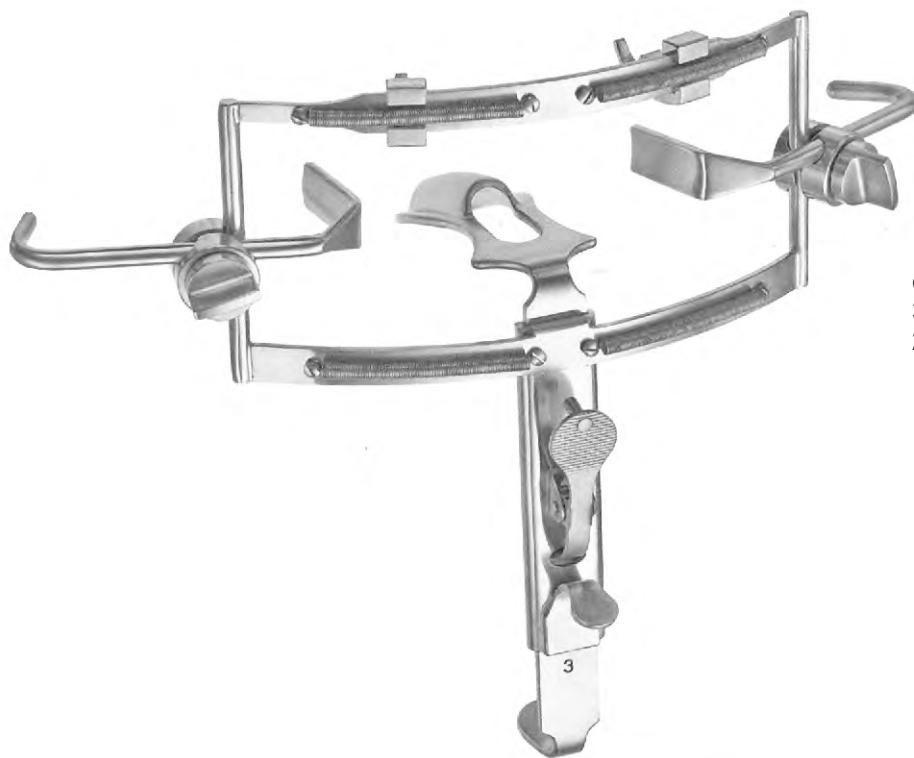

complete with frame,
 3 tongue depressors,
 2 tooth plates

DINGMANN
 GM 70-3114
 14,5 cm/5 3/4"



65 x 25 mm

GM 70-3115
 13,5 cm/5 3/4"



GM 70 x 29 mm

GM 70-3116
 13,5 cm/5 3/4"



80 x 32 mm

GM 70-3117
 13,5 cm/5 3/4"





19 / 15 mm



GM 70-3118
16 cm / 6 1/4"



FRENZEL
GM 70-3119
16,5 cm / 6 3/4"

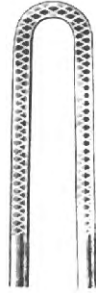

BRUENINGS
GM 70-3120
19 cm / 7 3/4"



BUCHWALD
GM 70-3121
19 cm / 7 3/4"



HARTMANN
GM 70-3122
15 cm / 6"

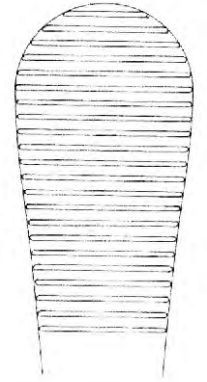

72 X 23 mm

24 / 30 mm

30 / 34 mm



GM 70-3123
13,5 cm / 5 3/4"

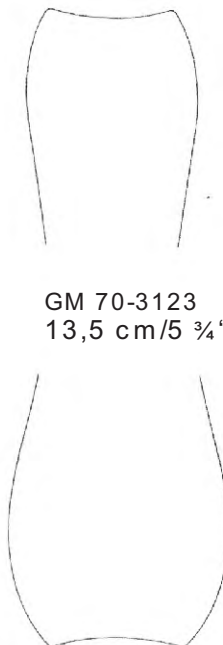

GM 70-3124
16 cm / 6 3/4"

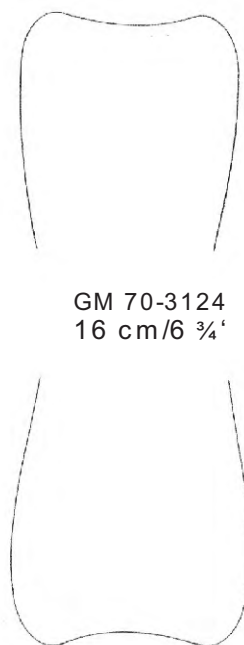

WIEDER

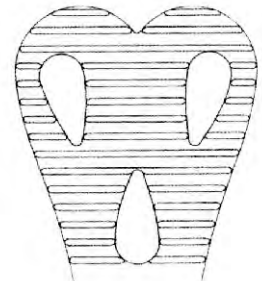

GM 70-3125
14 cm / 5 3/4"
36 mm

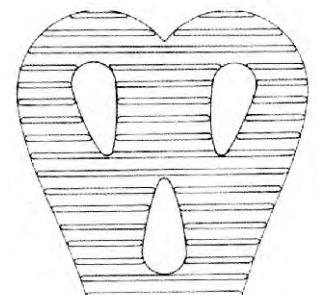

GM 70-3126
15 cm / 6"
43 mm



85 x 24 mm

TOBOLD
 GM 70-3127
 14,5 cm/5 3/4"

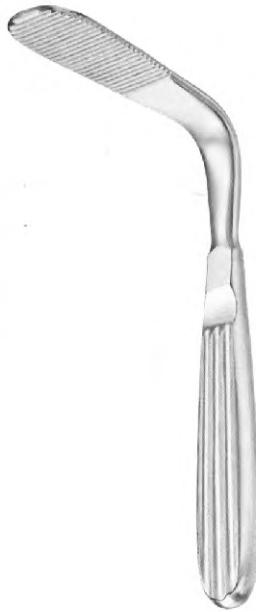

88 x 25 mm

TOBOLD
 GM 70-3128
 15 cm/6"



STERNBERG
 GM 70-3129
 14 cm/5 3/4"



SIMPLEX
 GM 70-3130
 11 cm/4 3/4"



CAWOOD-MINNESOTA
 GM 70-3131
 14 cm/5 3/4"



CAWOOD-MINNESOTA
 GM 70-3132
 15 cm/6"
 20 mm



GM 70-3133
 19 cm/7 3/4"



71

- EN** Scissors
- DE** Schere
- ES** Tijeras

Page 153 to 171

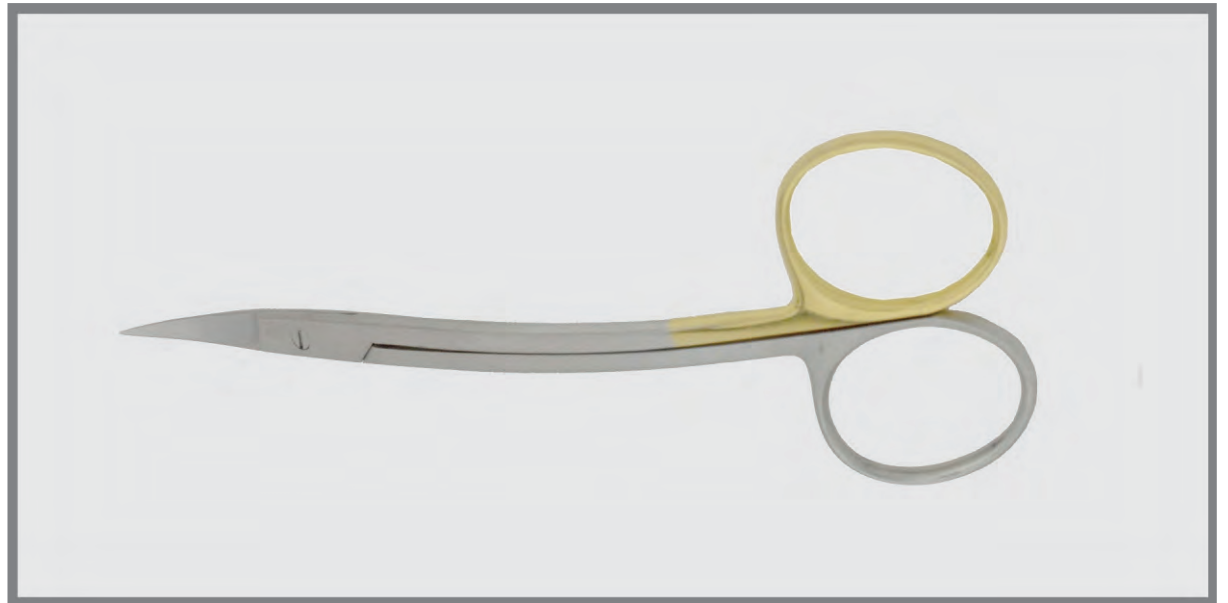



GM 71-3200
 universal
 12 cm/4 1/8"

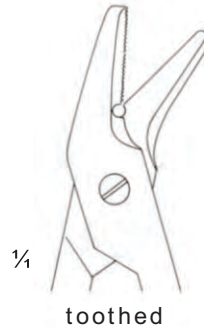

GM 71-3201 TC
 universal
 12 cm/4 1/8"



Beebee
 10.5 cm/4 1/8"

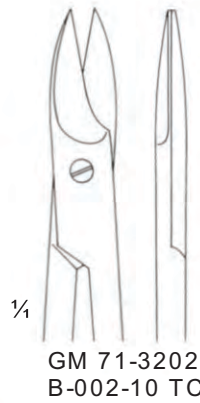

one toothed cutting edge



Beebee
 10.5 cm/4 1/8"



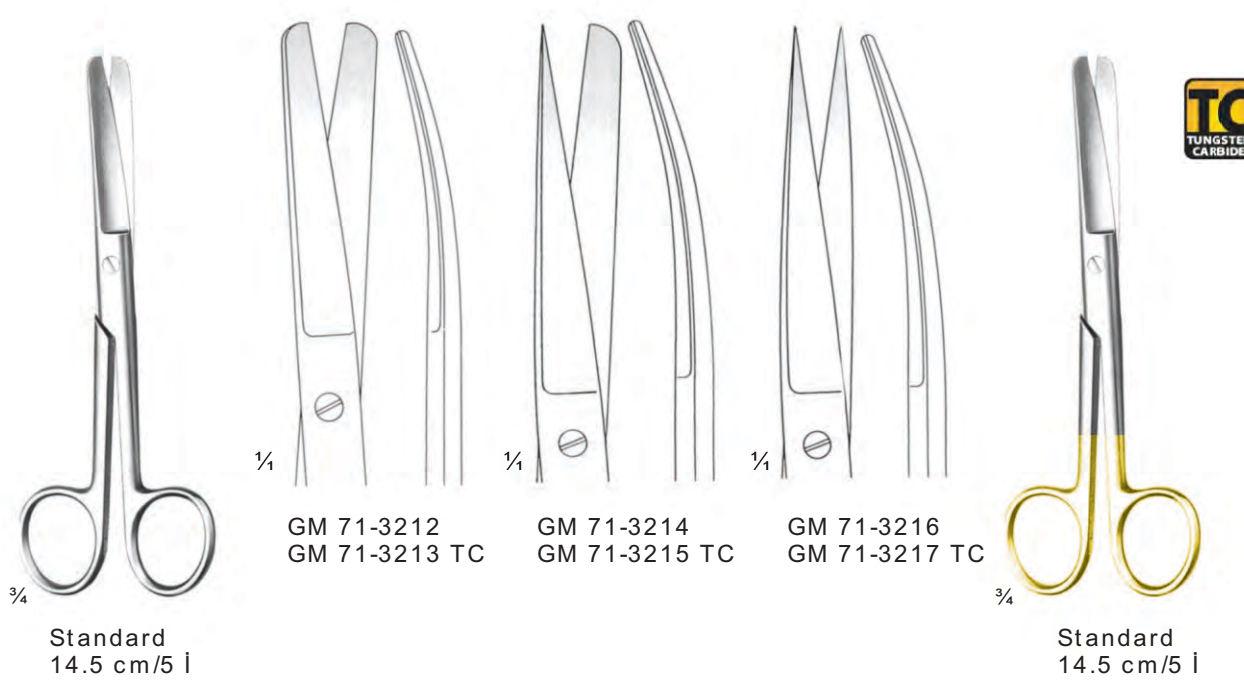
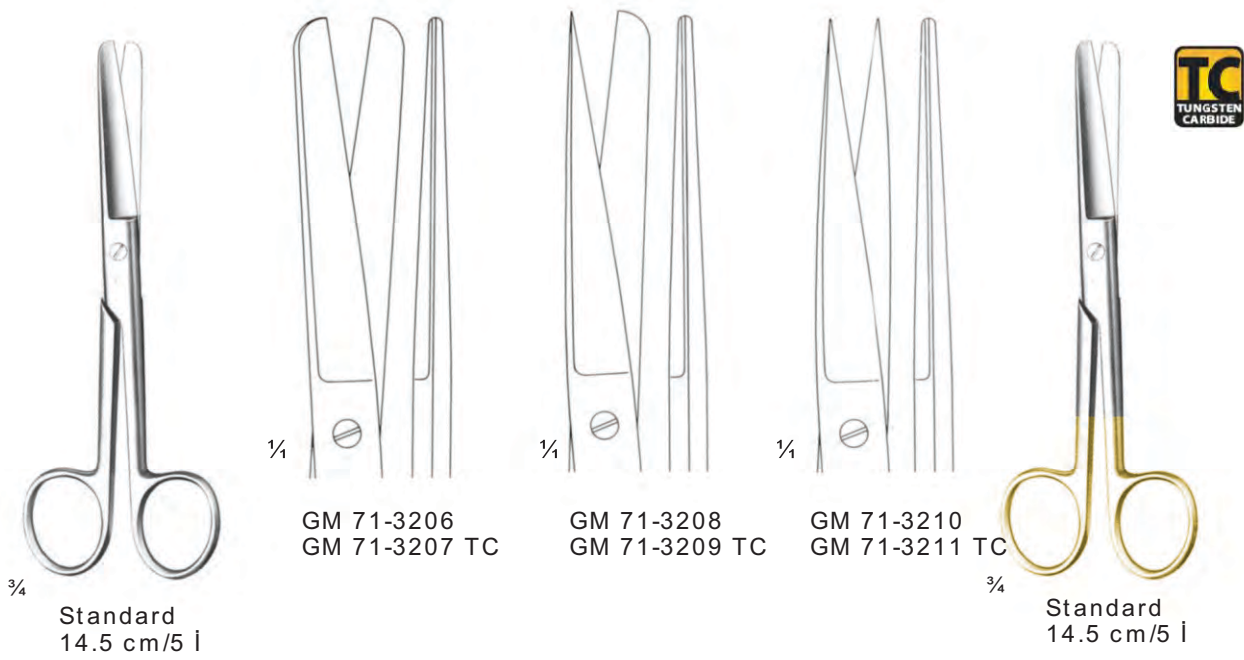

DELICATE

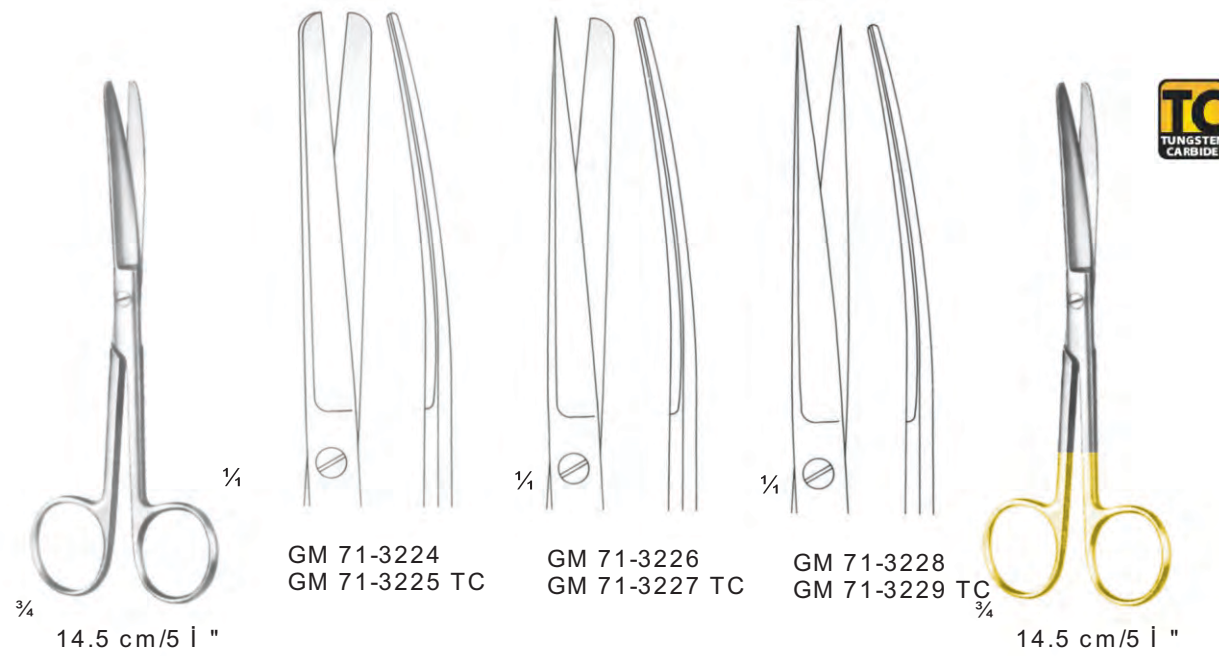
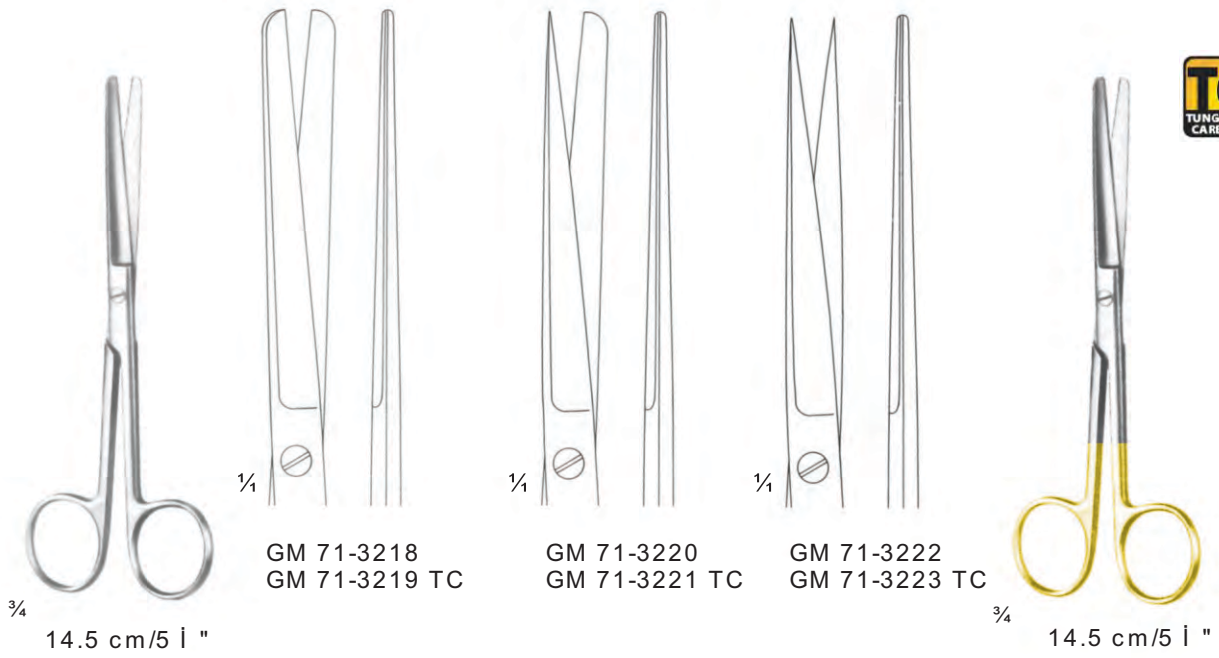



1/2

Kelly
16 cm/6 F "

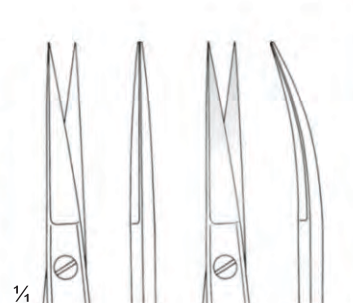

GM 71-3230 GM 71-3232
 GM 71-3231 TC GM 71-3233 TC



1/2

Kelly
16 cm/6 F "

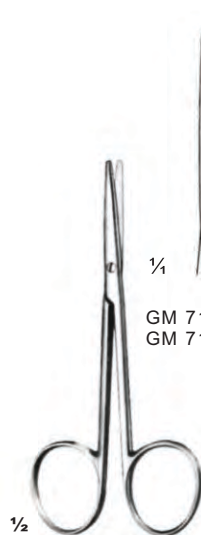

1/2

Metzenbaum
11.5 cm/4 5/8 "

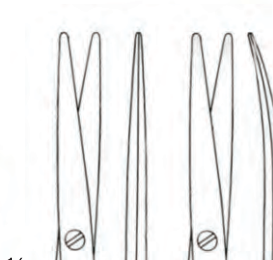

GM 71-3234 GM 71-3236
 GM 71-3235 TC GM 71-3237 TC



1/2

Metzenbaum
14 cm/5 5/8 "

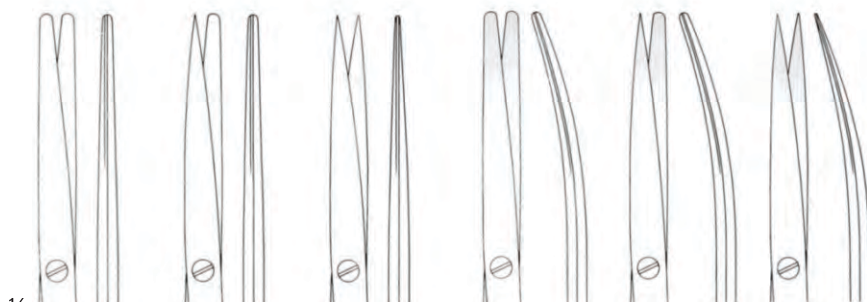

GM 71-3238 GM 71-3240 GM 71-3242 GM 71-3244 GM 71-3246 GM 71-3248
 GM 71-3239 TC GM 71-3241 TC GM 71-3243 TC GM 71-3245 TC GM 71-3247 TC GM 71-3249 TC



1/2

Metzenbaum
14 cm/5 5/8 "



DELICATE



Metzenbaum
15.5 cm/6'

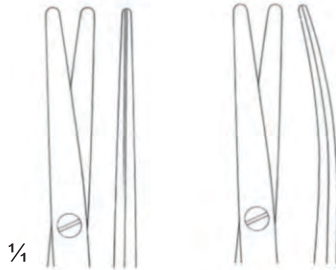

GM 71-3250 GM 71-3252
 GM 71-3251 TC GM 71-3253 TC



Metzenbaum
15.5 cm/6'



Metzenbaum-Nelson
18 cm/7'

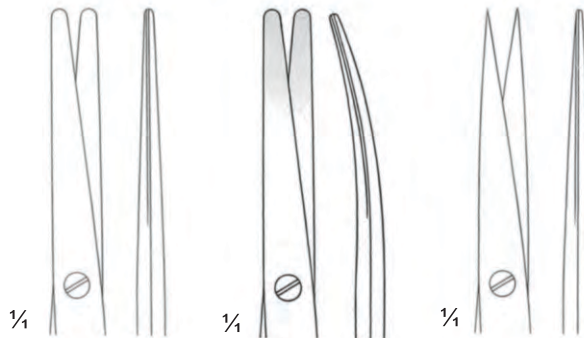

GM 71-3254 GM 71-3256 GM 71-3258
 GM 71-3255 TC GM 71-3257 TC GM 71-3259 TC



Metzenbaum-Nelson
18 cm/7'



Metzenbaum
 14.5 cm/5 1/2 "

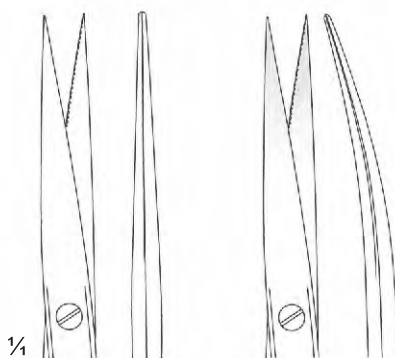

GM 71-3260

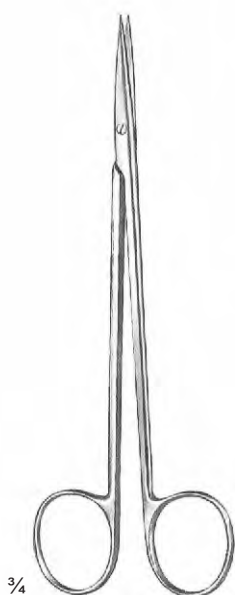

Nerve dissecting scissors
 15.5 cm/6'

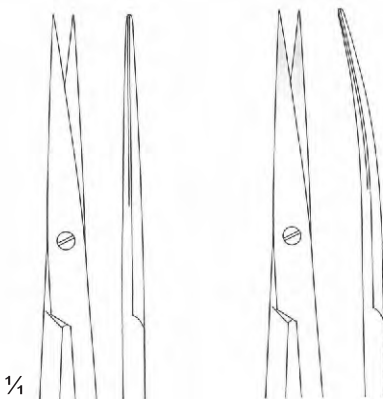

GM 71-3262

GM 71-3263





Lexer-Fino
slender pattern
16.5 cm/6 5/8"

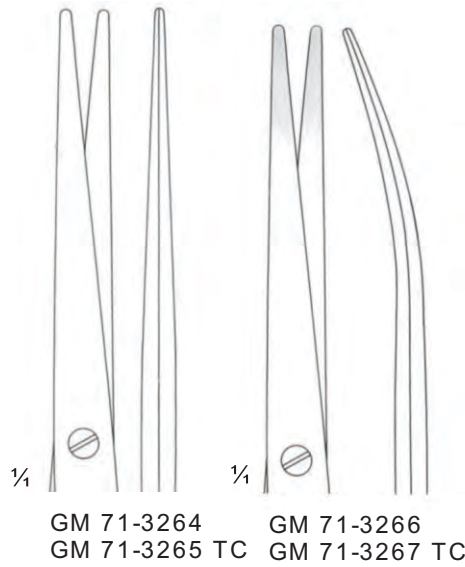

GM 71-3264 GM 71-3266
GM 71-3265 TC GM 71-3267 TC



Lexer-Fino
slender pattern
16.5 cm/6 5/8"



Metzenbaum-Fino
slender pattern
14.5 cm/5 3/4"

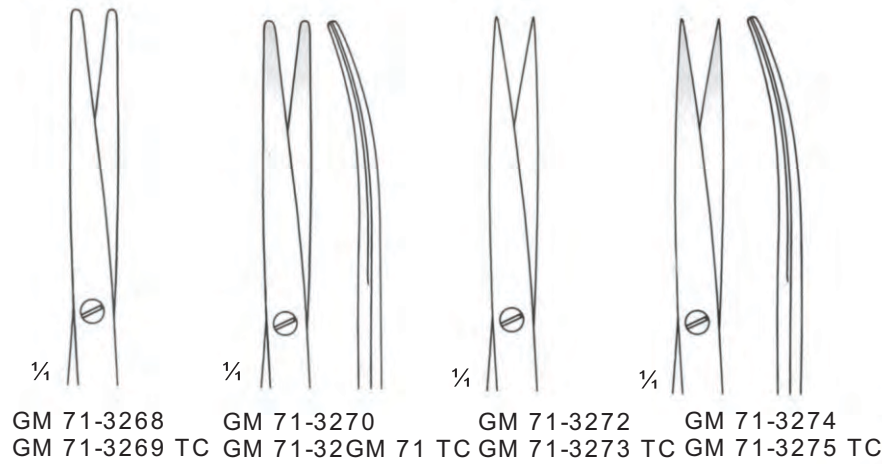

GM 71-3268 GM 71-3270 GM 71-3272 GM 71-3274
GM 71-3269 TC GM 71-3271 TC GM 71-3273 TC GM 71-3275 TC



Metzenbaum-Fino
slender pattern
14.5 cm/5 3/4"



Metzenbaum-Fino
 slender pattern
 18 cm/7'

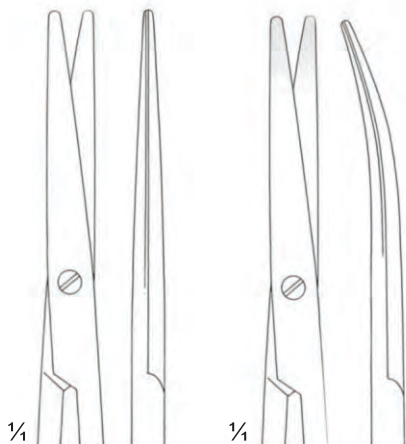

GM 71-3276 GM 71-3278
 GM 71-3277 TC GM 71-3279 TC



Metzenbaum-Fino
 slender pattern
 18 cm/7'

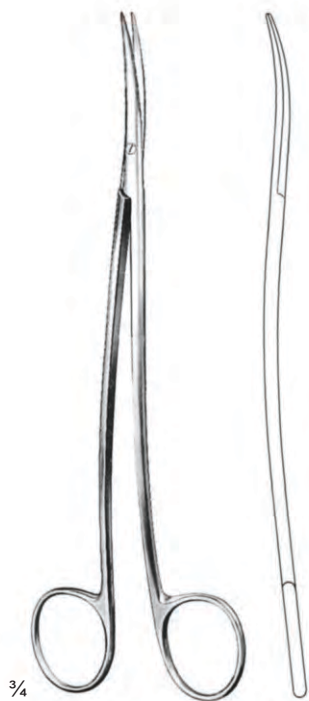

Metzenbaum-Fino
 S shaped
 18 cm/7'



GM 71-3280
 GM 71-3281 TC



Metzenbaum-Fino
 S shaped
 18 cm/7'

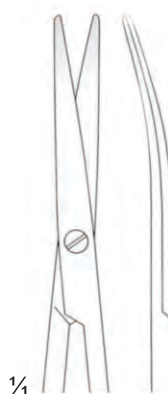

GM 71-3282
 12.5 cm/5'

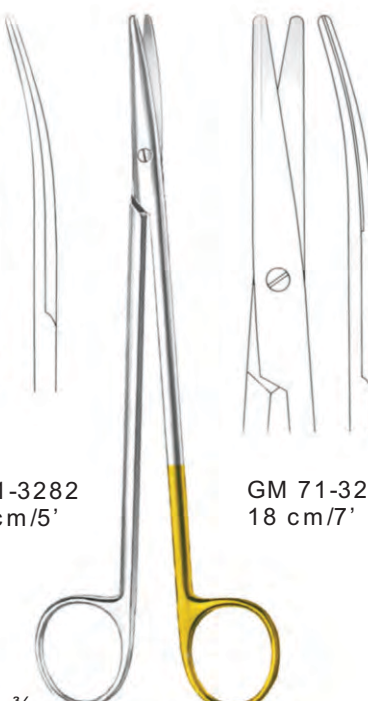

Salyer
 fine model for cleft palate
 18 cm/7'

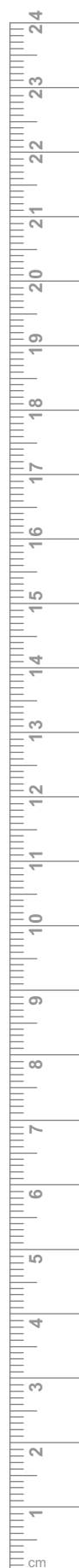





GM 71-3295 GM 71-3297
 GM 71-3296 TC GM 71-3298 TC

GOLDMANN-FOX
 13 cm/5 1/8"

GOLDMANN-FOX
 13 cm/5 1/8"



GM 71-3299 GM 71-3301
 GM 71-3300 TC GM 71-3302 TC

Toothed Blades

GOLDMANN-FOX
 13 cm/5 1/8"

GOLDMANN-FOX
 13 cm/5 1/8"

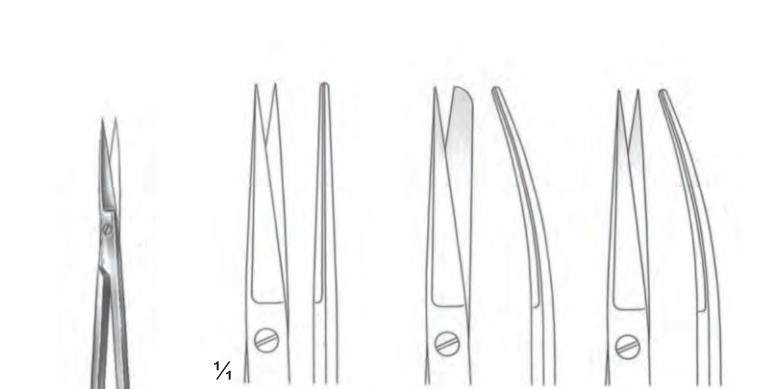

GM 71-3303 GM 71-3304 GM 71-3305

Small modle
 12 cm/4 1/2"



slender pattern
 GM 71-3306
 GM 71-3307 TC

Toennis-Adson
 17.5 cm/7"

Toennis-Adson
 17.5 cm/7"

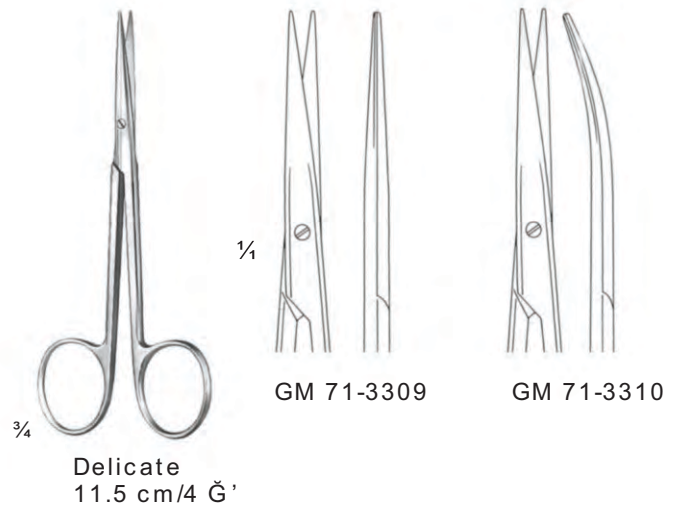

one toothed cutting edge

one toothed cutting edge

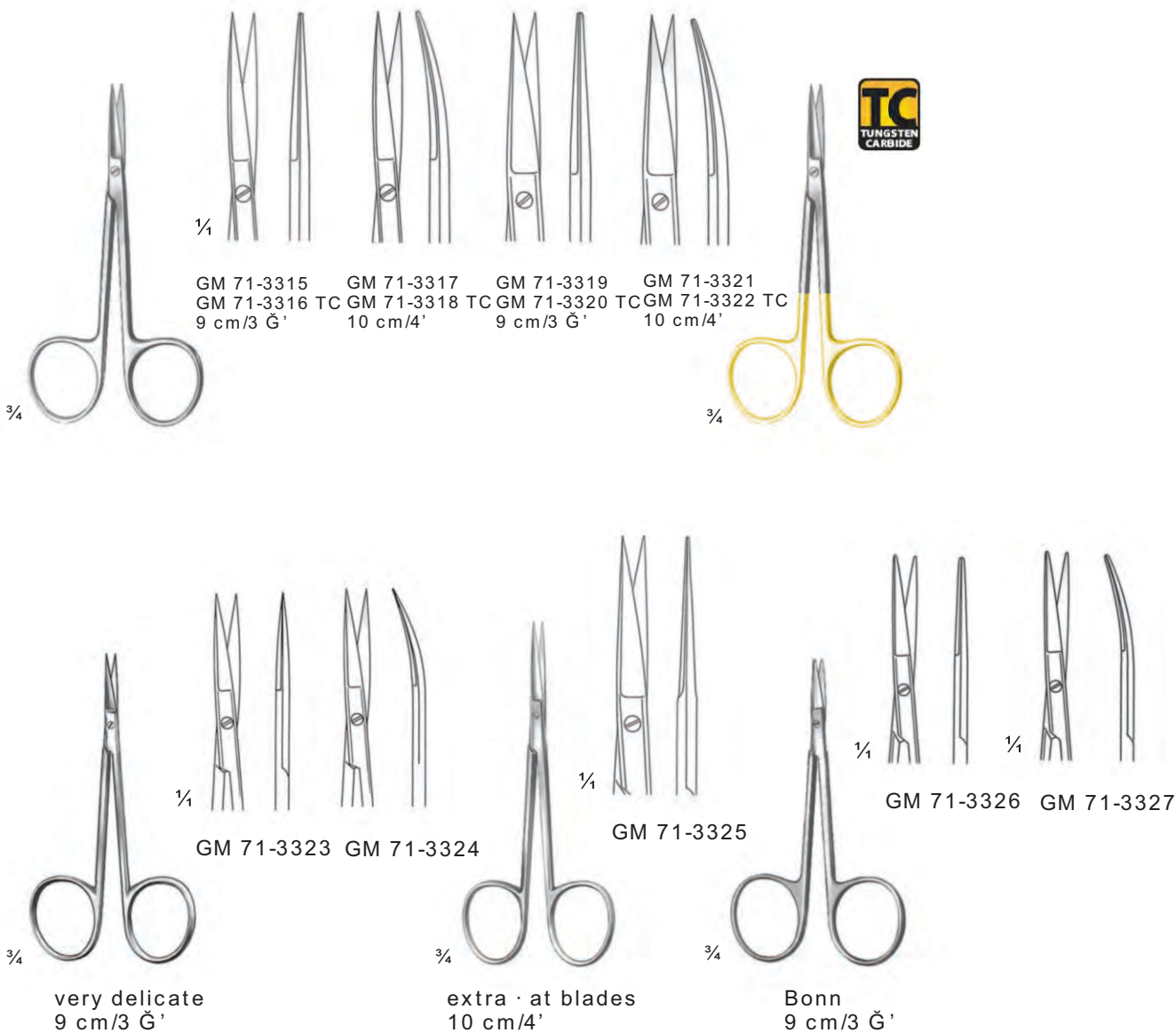



11.5 cm/4 3/8"



GM 71-3328
 GM 71-3329 TC
 GM 71-3330
 GM 71-3331 TC
 GM 71-3332
 GM 71-3333 TC
 GM 71-3334
 GM 71-3335 TC



11.5 cm/4 3/8"



12.5 cm/5"

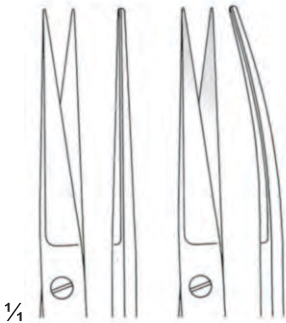

GM 71-3336 GM 71-3337



Stevens
 11 cm/4 3/8"

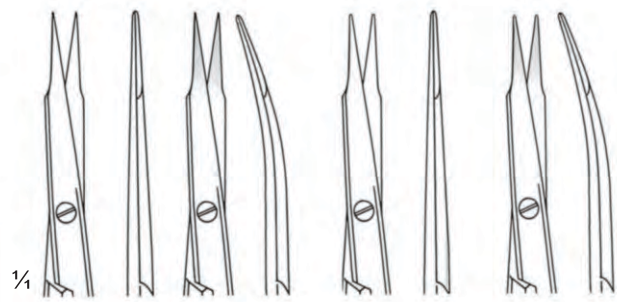

GM 71-3338 sharp
 GM 71-3339 sharp
 GM 71-3340 blunt
 GM 71-3341 blunt

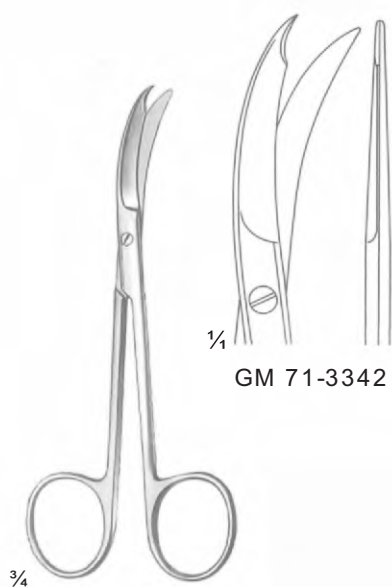

GM 71-3342

Northbent
13 cm/5'



GM 71-3343
9 cm/3 1/2'

Spencer



GM 71-3344
13 cm/5'

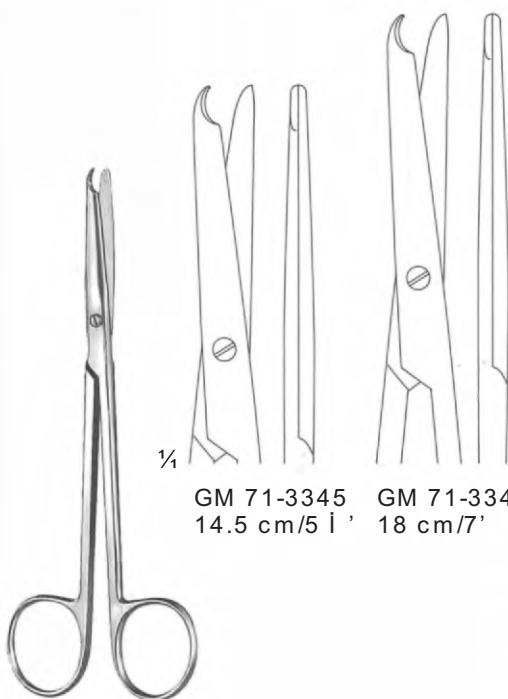

GM 71-3345
14.5 cm/5 3/4'

Buck



GM 71-3346
18 cm/7'



GM 71-3347

Littauer
14 cm/5 1/2'

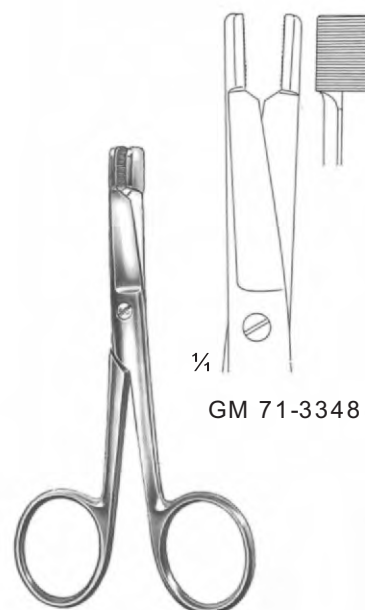

GM 71-3348

Eiselsberg
12 cm/4 3/4'



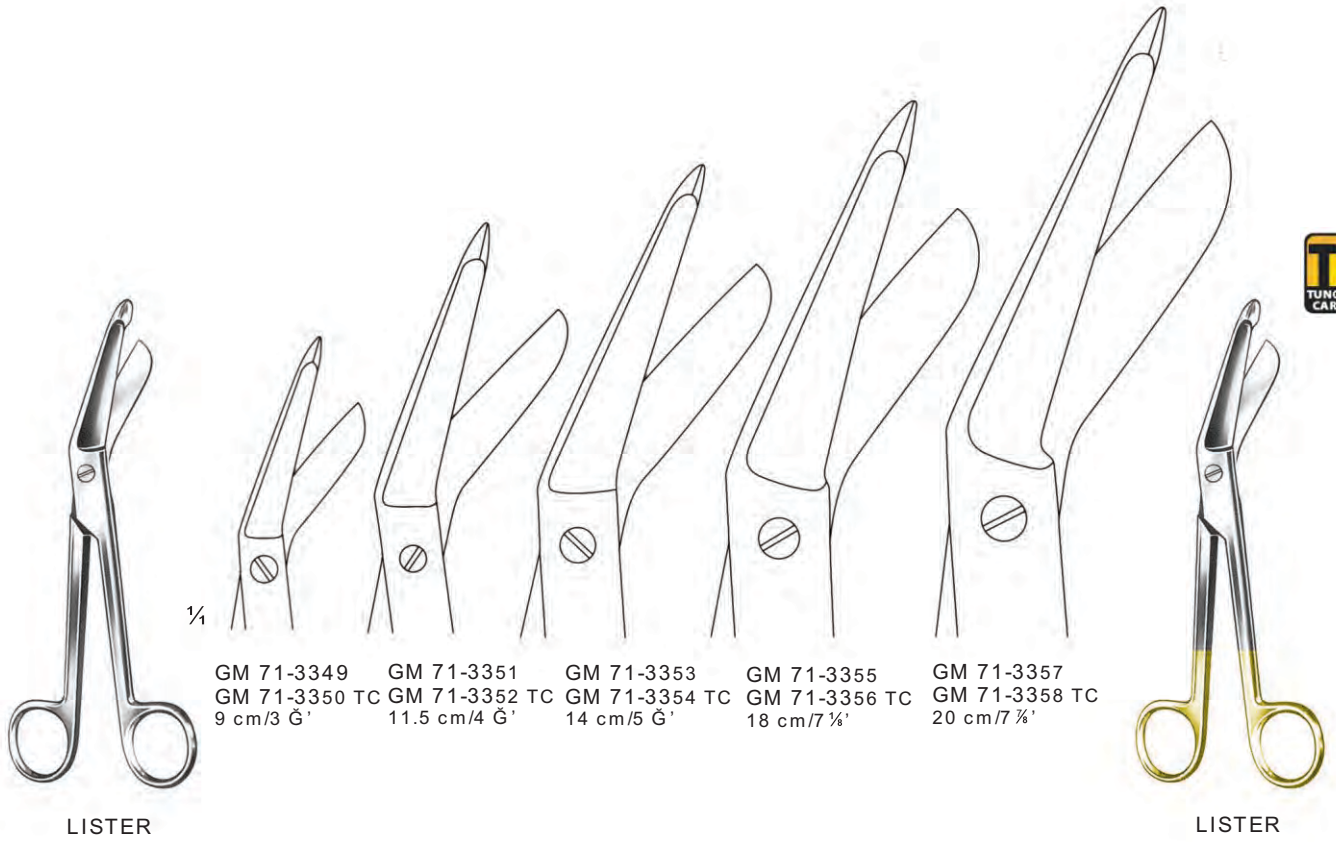

GM 71-3349 GM 71-3351 GM 71-3353 GM 71-3355 GM 71-3357
 GM 71-3350 TC GM 71-3352 TC GM 71-3354 TC GM 71-3356 TC GM 71-3358 TC
 9 cm/3 1/2" 11.5 cm/4 1/2" 14 cm/5 1/2" 18 cm/7 1/4" 20 cm/7 7/8"

LISTER

LISTER

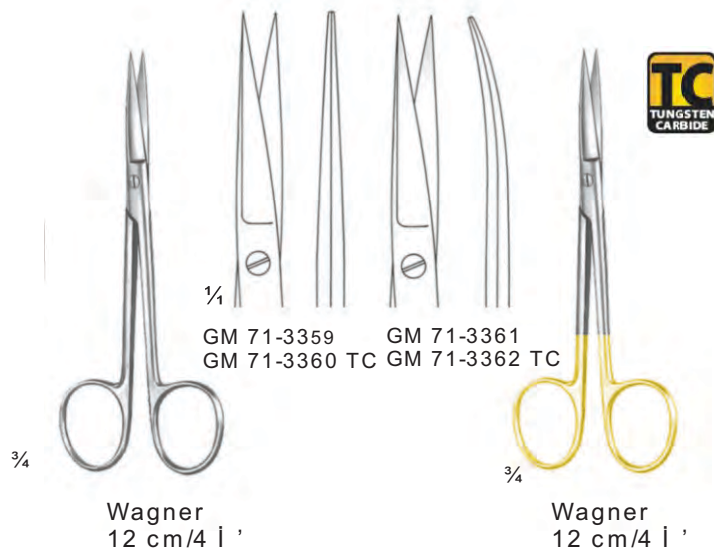

GM 71-3359 GM 71-3361
 GM 71-3360 TC GM 71-3362 TC

Wagner
12 cm/4 3/4"

Wagner
12 cm/4 3/4"

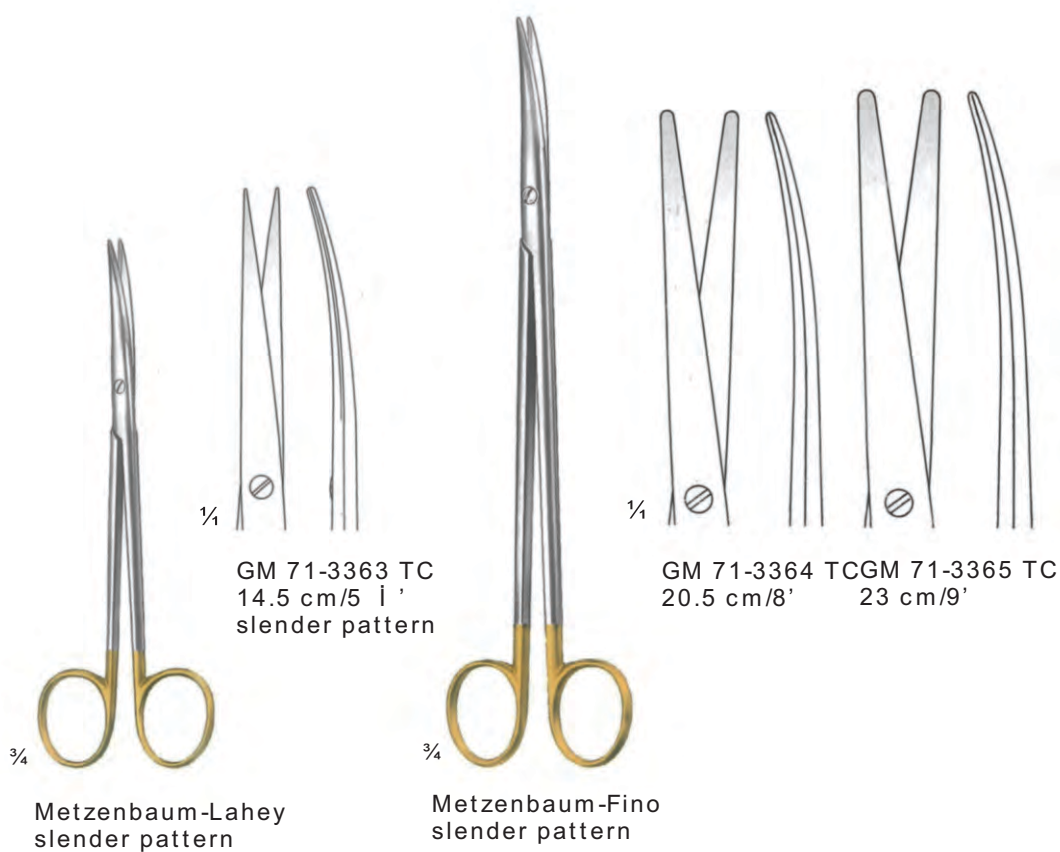



Ragnell





¾

Metzenbaum

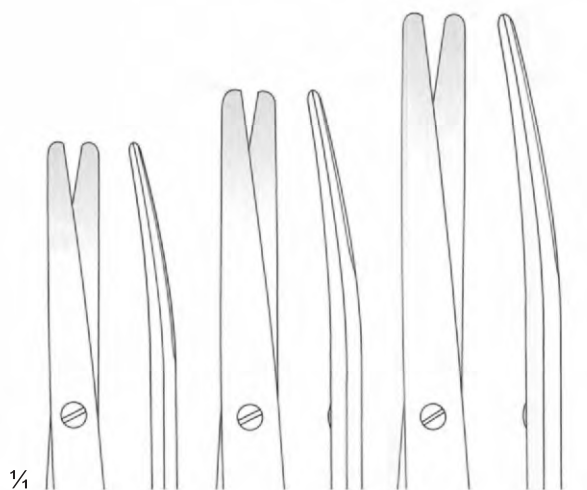

¼

GM 71-3370
18 cm/7'

GM 71-3371
20 cm/8'

GM 71-3372
23 cm/8'

Fine cutting edge

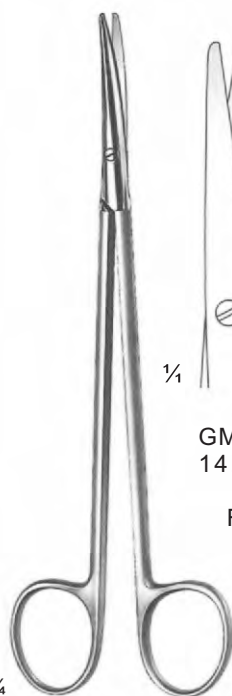

¾

Metzenbaum

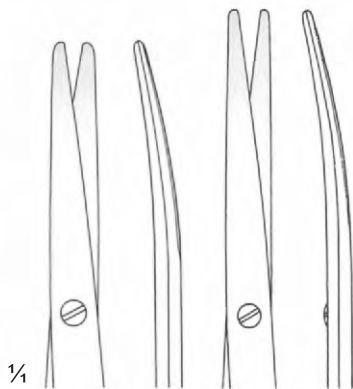

¼

GM 71-3373
14.5 cm/5 ½'

GM 71-3374
18 cm/7'

Fine cutting edge



¾

Mayo-Lexer
Standard Pattern



¼

GM 71-3375
16 cm/6 ¼'

Fine cutting edge



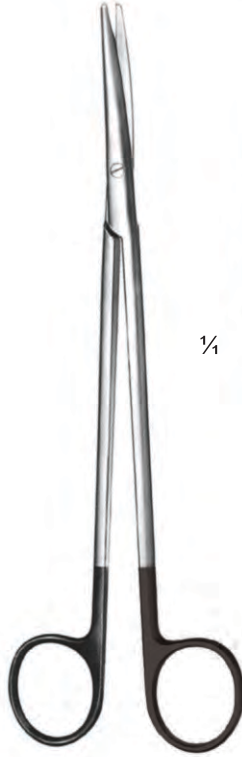

¼



GM 71-3376 TCS
14.5 cm/5 1/2"

GM 71-3377 TCS
18 cm/7"

For synthetic suture material
One toothed cutting edge

¾



¼



GM 71-3378 TCS
14.5 cm/5 1/2"

GM 71-3379 TCS
17 cm/6 3/4"

For synthetic suture material
One toothed cutting edge

¾

72

- EN** Micro Scissors
- DE** Mikroschere
- ES** Micro tijeras

Page 172 to 173

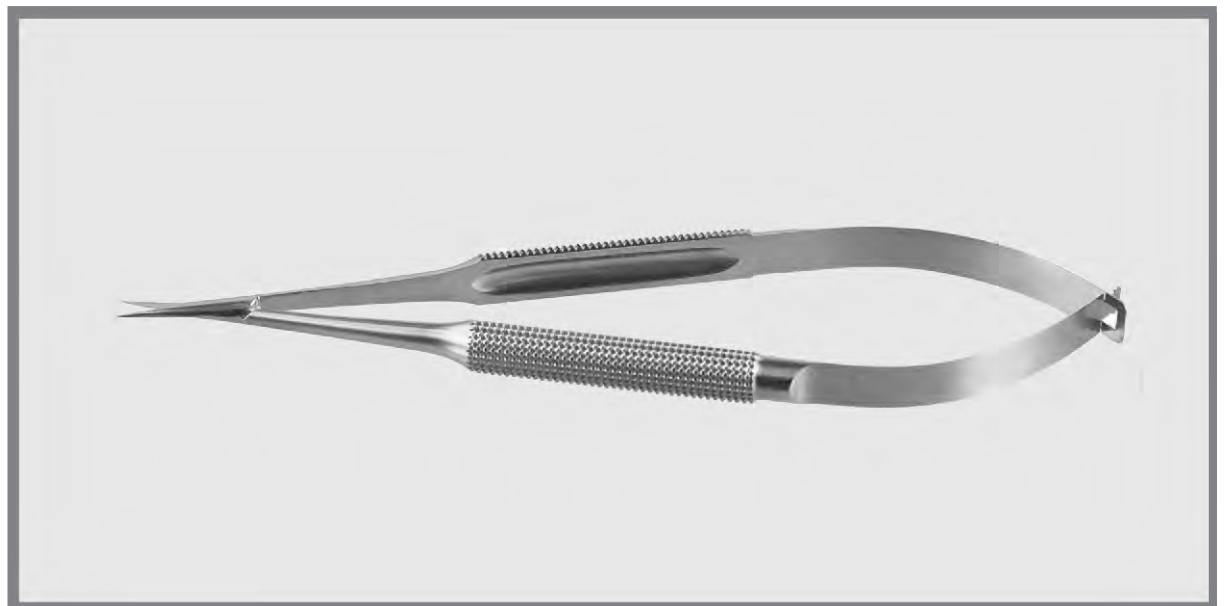

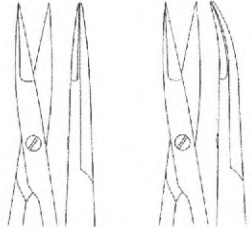

15 cm/6" GM 72-3401 GM 72-3405
 18 cm/7" GM 72-3402 GM 72-3406
 21 cm/8 1/4" GM 72-3403 GM 72-3407
 23 cm/9" GM 72-3404 GM 72-3408

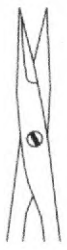

Streamlined

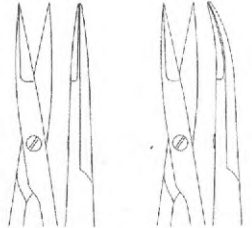

15 cm/6" GM 72-3409 GM 72-3413
 18 cm/7" GM 72-3410 GM 72-3414
 21 cm/8 1/4" GM 72-3411 GM 72-3415
 23 cm/9" GM 72-3412 GM 72-3416



Streamlined



NOYES
GM 72-3417
13 cm/5"



73

- EN** Orthodontics
- DE** Kieferorthopädie
- ES** Ortodoncia

Page 174 to 190

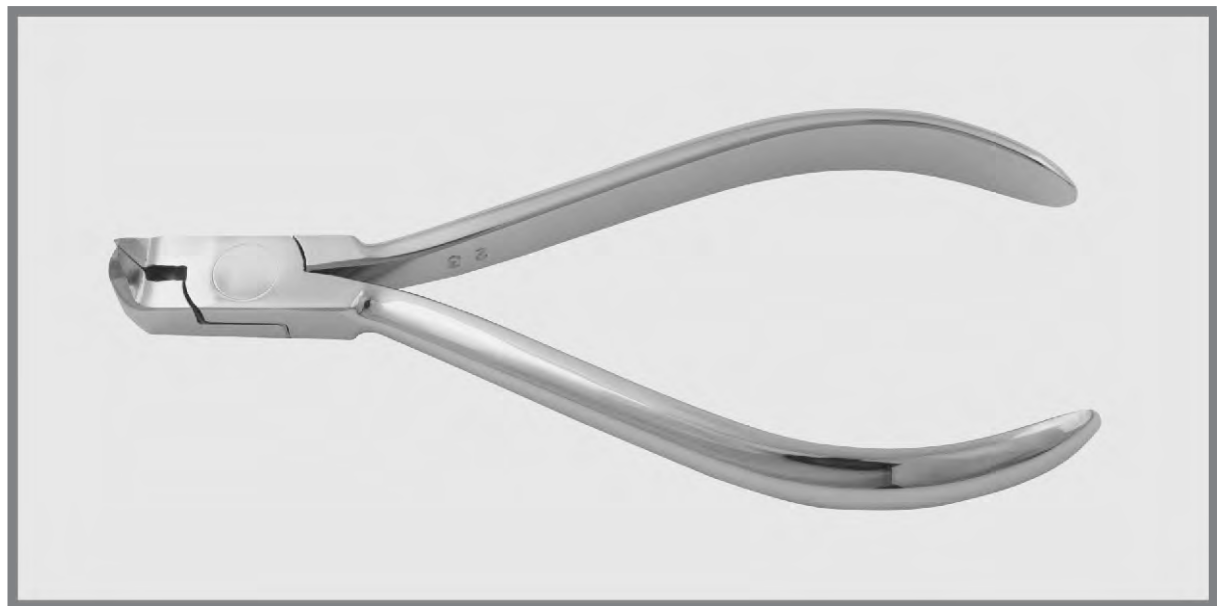



GM 73-3501
14 cm/5 1/2"



LANGENBECK
GM 73-3502
15 cm/6"



GM 73-3503
14 cm/5 1/2"



GM 73-3504
12,5 cm/4 3/4"



GM 73-3505
13 cm/5"



GM 73-3506
14 cm/5 1/2"





Contouring pliers

GOSLEE
GM 73-3507
14 cm/5 1/2"



Contouring pliers

GOSLEE
GM 73-3508
14 cm/5 1/2"



Contouring pliers

GOSLEE
GM 73-3509
14 cm/5 1/2"



serrated

GM 73-3510
12,5 cm/4 3/4"



round

Flat

GM 73-3511
15 cm/6"



round
nose pliers

GM 73-3512
13 cm/5"





GM 73-3513
13 cm/5"



GM 73-3514
13 cm/5"



LANGENBECK
GM 73-3515
14 cm/5 1/2"



DUMONT
GM 73-3516
11,5 cm/4 1/2"



DUMONT
GM 73-3517
11,5 cm/4 1/2"



DUMONT
GM 73-3518
11,5 cm/4 1/2"



Wire cutter, front action



GM 73-3519
 11 cm/4 1/4"



GM 73-3520
 11,5 cm/4 1/2"



GM 73-3521
 12,5 cm/4 3/4"



GM 73-3522
 11,5 cm/4 1/2"



GM 73-3523
 11,5 cm/4 1/2"

0,7 mmØ
 for hard wire up to





1,0 mm Ø
 for hard wire up to



GM 73-3524
 15 cm/6"



SCHWARZ
 GM 73-3525
 13 cm/5"
 Modell I

SCHWARZ
 GM 73-3528
 14,5 cm/5 3/4"



SCHWARZ
 GM 73-3526
 13 cm/5"
 Modell II

FISCHER
 GM 73-3529
 14 cm/5 1/2"





ANDRESEN
 GM 73-3530
 13,5 cm/5 1/2"



 sling forming pliers

McKELLOPS
 GM 73-3531
 17 cm/6 3/4"



McKELLOPS-STADLER
 GM 73-3532
 16 cm/6 1/4"



STADLER
 GM 73-3533
 15 cm/6"



 Flat 
 round

ANGLE
 GM 73-3534
 12,5 cm/5"



ANGLE
 GM 73-3535
 12,5 cm/5"





ADAMS
 GM 73-3536
 13 cm/5"



YOUNG
 GM 73-3537
 13 cm/5"



TWEED
 GM 73-3538
 13,5 cm/5 1/2"



TWEED
 GM 73-3539
 13,5 cm/5 1/2"



DE LA ROSA
 GM 73-3540
 12,5 cm/5"

Contouring pliers



DE LA ROSA
 GM 73-3541
 12,5 cm/5"





JARABAK
GM 73-3542
14 cm/5 1/2"

ovalen Draht bis
hart 1,5 x 0,75 mm

oval wire up to
1.5 x 0.75 mm



ADERER
GM 73-3543
14 cm/5 1/2"

0,7 mm Ø
hard wire up to



GM 73-3545
14 cm/5 1/2"

0,7 mm Ø
for hard wire up to

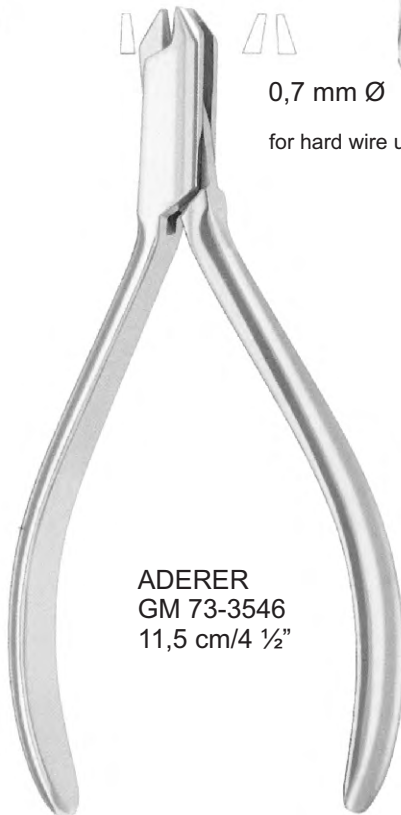

ADERER
GM 73-3546
11,5 cm/4 1/2"

0,7 mm Ø
for hard wire up to

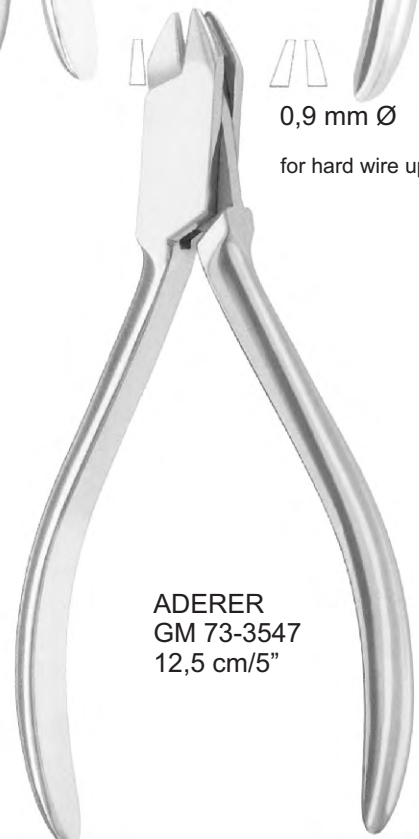

ADERER
GM 73-3547
12,5 cm/5"

0,9 mm Ø
for hard wire up to





Bending Pliers

ANGLE
 GM 73-3548
 13 cm/5"



ANGLE
 GM 73-3549
 13 cm/5"



WALDSACHS
 GM 73-3550
 15,5 cm/6"



Universal
 GM 73-3551
 15,5 cm/6 1/4"



GM 73-3552
 15,5 cm/6 1/4"



FURRER
 GM 73-3553
 15 cm/6"

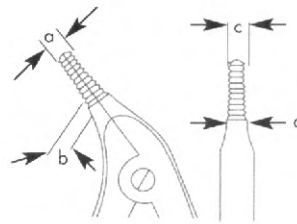

a	b	c	d
3,3	4	2,3	3,0
4,4	5	3,4	3,8

Telescope crown pliers



BOEHM
GM 73-3554
 12 cm/4 3/4"



BOEHM
GM 73-3555
 15 cm/4"





OLIVER
 JONES
 GM 73-3556
 15 cm/6"



OLIVER
 GM 73-3557
 15 cm/6"



OLIVER
 GM 73-3558
 15 cm/6"

Step loop bending pliers



ADERER
 GM 73-3559
 13,5 cm/5 1/4"



NANCE
 GM 73-3560
 12,5 cm/5"





WEINGART
GM 73-3561
14 cm/5 1/2"

serrated, curved



WEINGART
GM 73-3562
14 cm/5 1/2"

serrated, curved



KORKHAUS
GM 73-3563
16,5 cm/6 1/2"



GM 73-3564
12 cm/4 3/4"

Distal cutter

0,7 mm Ø

for hard wire up to



ANGLE
GM 73-3565
13 cm/5"



ANGLE
GM 73-3566
13 cm/5"





TRYFUS
 GM 73-3567
 16 cm/6 1/4"

Crown stretching pliers



PEESO
 GM 73-3568
 12 cm/6 1/4"

smooth



HOW
 GM 73-3571
 14 cm/5 1/2"

straight



PEESO
 GM 73-3569
 13,5 cm/5 1/4"

serrated



HOW
 GM 73-3572
 14 cm/5 1/2"

curved



GM 73-35GM 73
18 cm/7"



GM 73-3574
14,5 cm/5 ¾"





FREVERT
 GM 73-3575
 12 cm/4 ¾"



TRIPLEX
 GM 73-3576
 14 cm/5 ½"



REYNOLD
 GM 73-3577
 12 cm/4 ¾"



GORDON
 GM 73-3578
 13,5 cm/5 ¼"



JOHNSON
 GM 73-3579
 13 cm/5"



Clamping tweezer / bracket holder

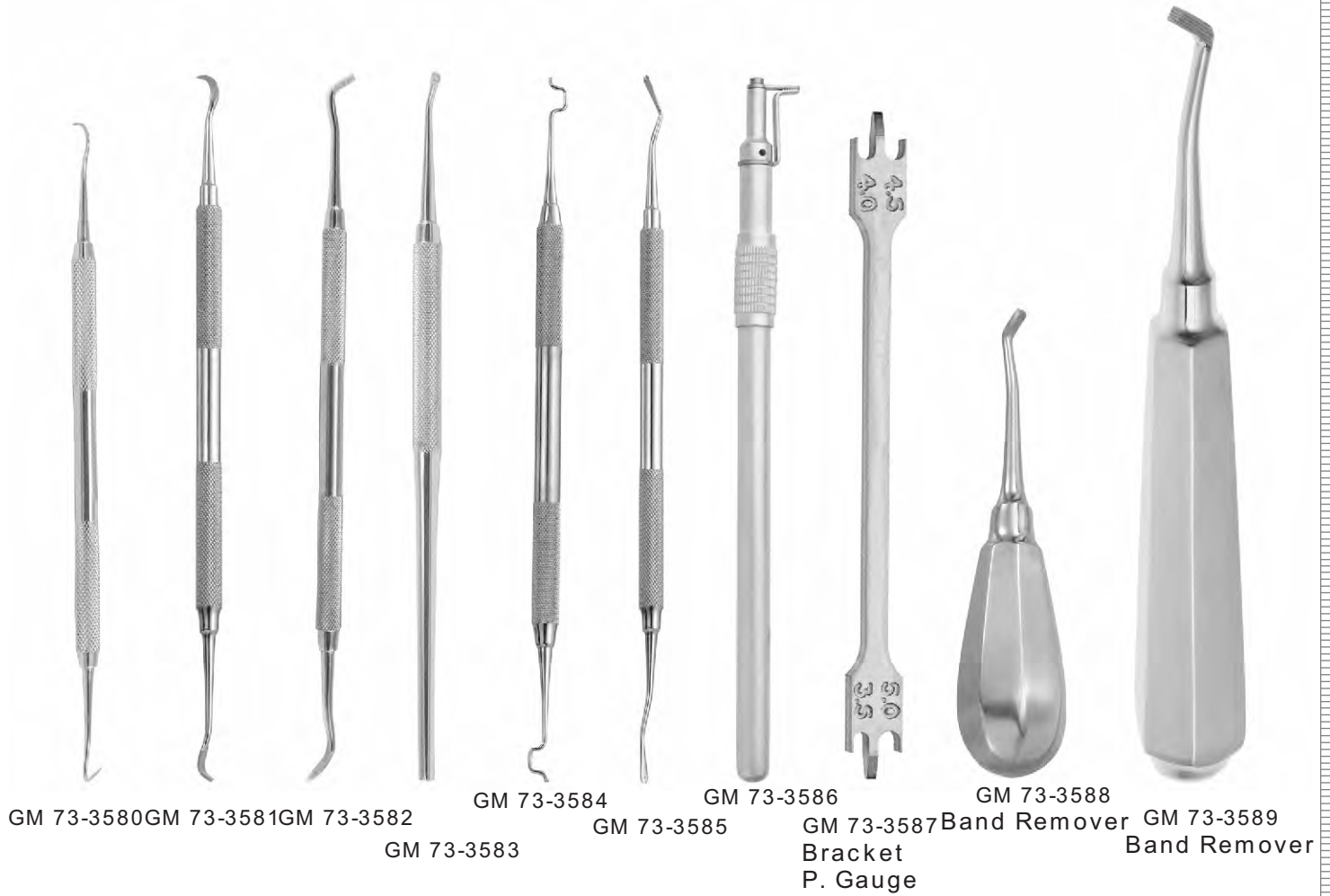

Bracket positioning gauge



GM 73-3590





GM 73-3591
12.5 cm/5"



GM 73-3592
12.5 cm/5"



GM 73-3593
12.5 cm/5"



GM 73-3594
12.5 cm/5"



GM 73-3595
12.5 cm/5"



GM 73-3596
12.5 cm/5"



GM 73-3597
12.5 cm/5"



GM 73-3598
12.5 cm/5"



GM 73-3599
12.5 cm/5"



GM 73-3600
12.5 cm/5"



GM 73-3601
12.5 cm/5"



GM 73-3602
12.5 cm/5"

74

- EN** Bone Rongeurs
- DE** Knochen Rongeur
- ES** Rongeurs de hueso

Page 191 to 193

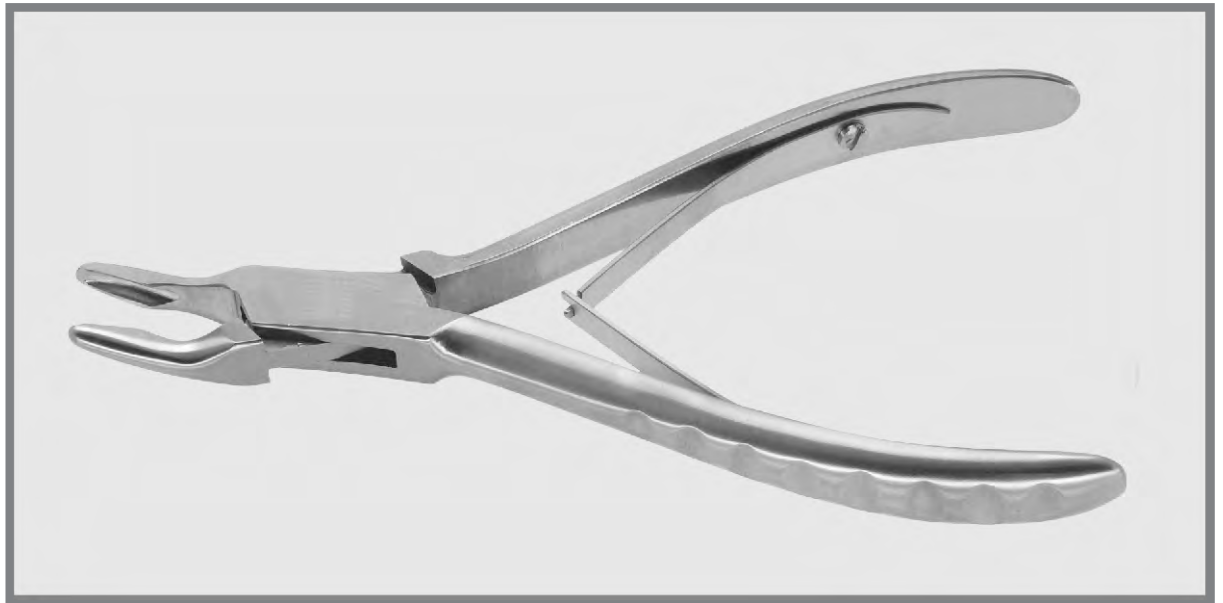

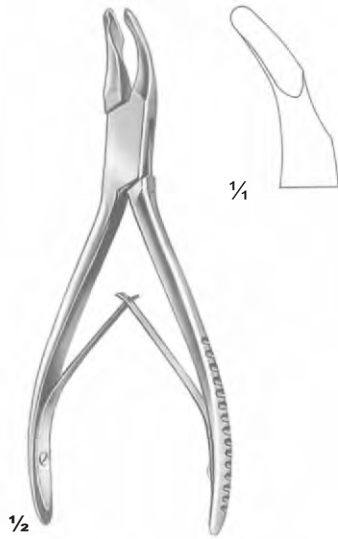

Cleveland
 GM 74-3701
 15 cm

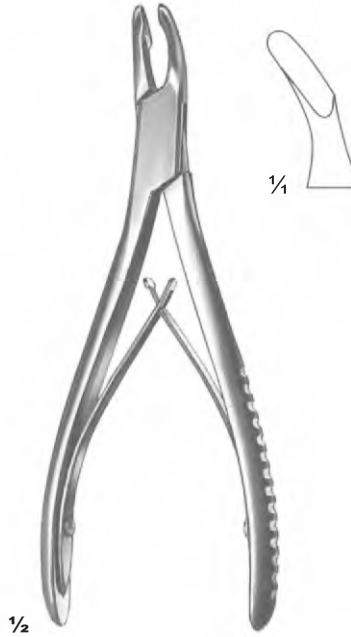

Cleveland
 GM 74-3702
 15 cm

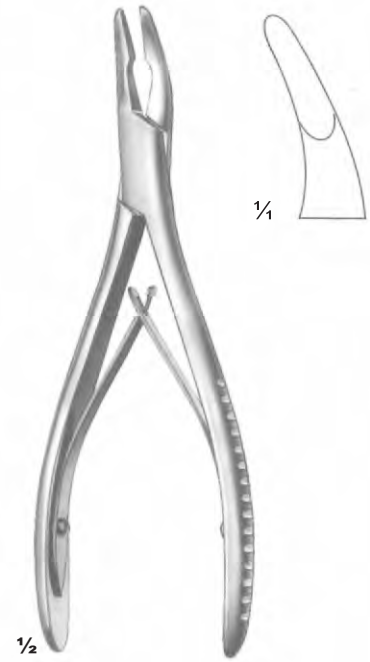

Hartmann
 GM 74-3703
 18 cm

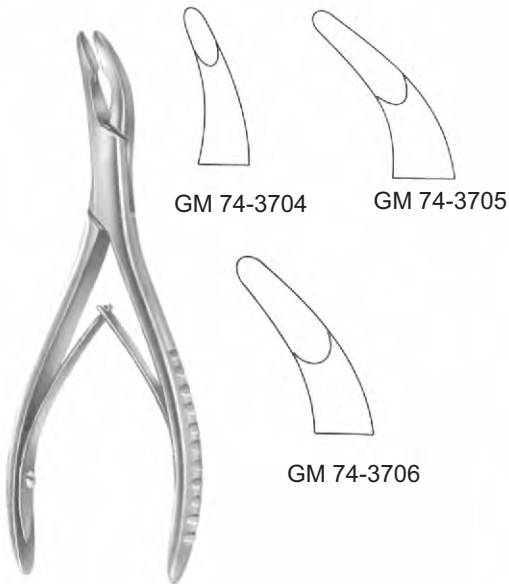

LUER
 15 cm

GM 74-3704

GM 74-3705

GM 74-3706

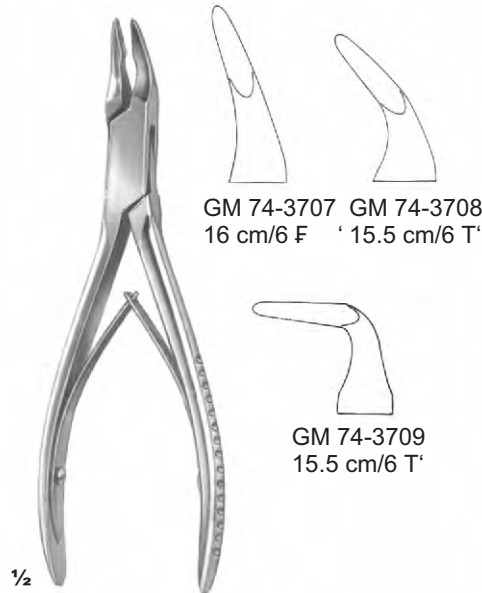

BLUMENTHAL
 15 cm

GM 74-3707 GM 74-3708
 16 cm/6 F ' 15.5 cm/6 T'

GM 74-3709
 15.5 cm/6 T'

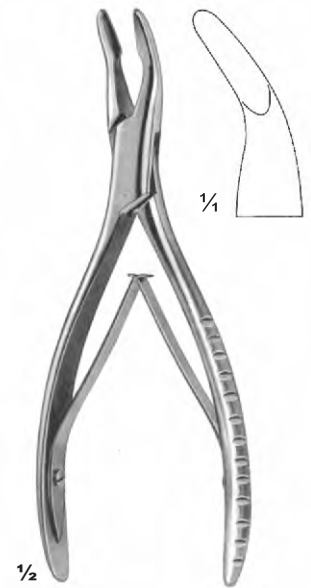

MEAD
 GM 74-3710
 16.5 cm/6 3/4'

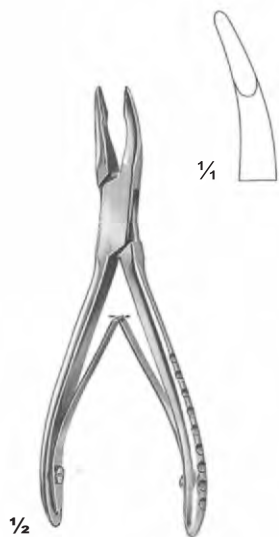

Friedmann
 GM 74-3711
 14 cm

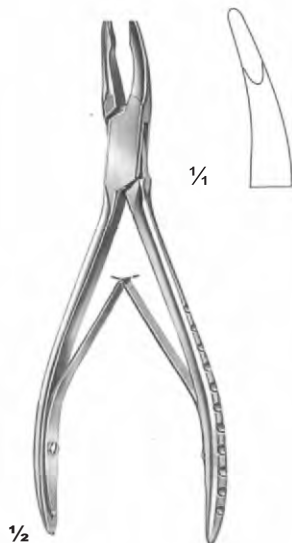

Friedmann
 GM 74-3712
 14 cm

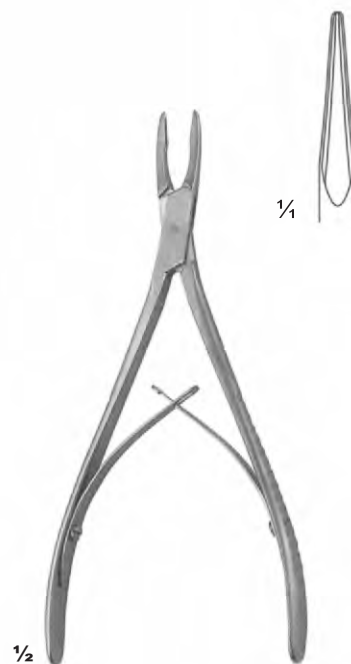

Friedmann-Micro
 GM 74-3713
 15 cm/6"
 straight

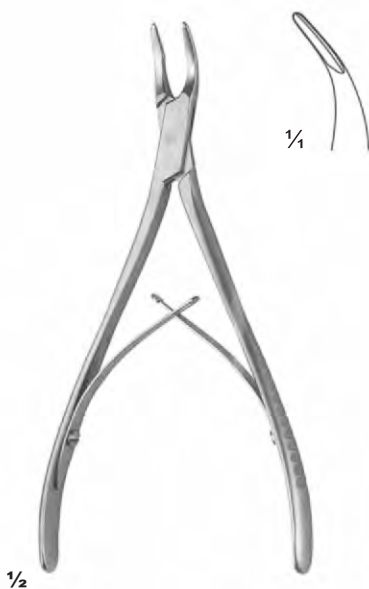

Friedmann-Micro
 GM 74-3714
 15 cm/6"
 30°



Friedmann-Micro
 GM 74-3715
 14.5 cm/5 1/2"
 90°

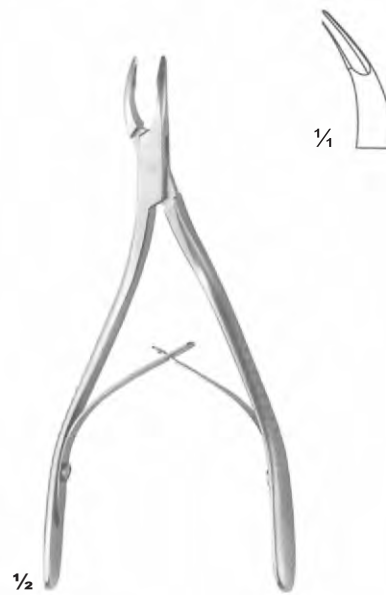

Friedmann-Micro
 GM 74-3716
 14.5 cm/5 1/2"
 S shape
 30°



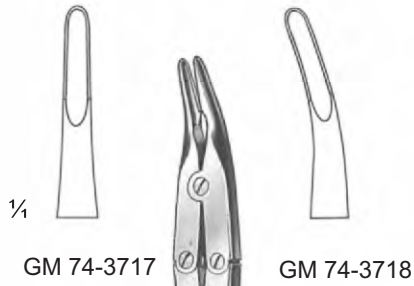

Bohler
15.5 cm/6"



Beyer
GM 74-3719
18 cm/7"

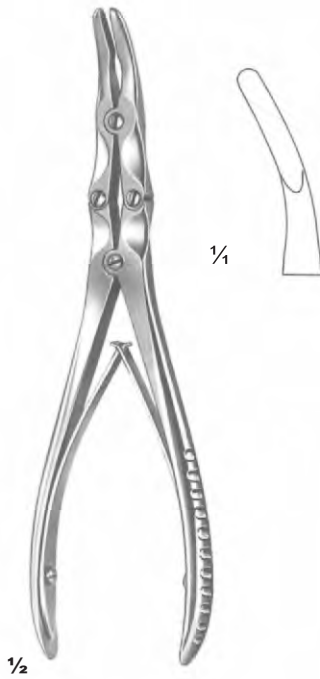

Mayfield
GM 74-3720
18 cm/7"



Zaufal-Jansen
GM 74-3721
18 cm/7"

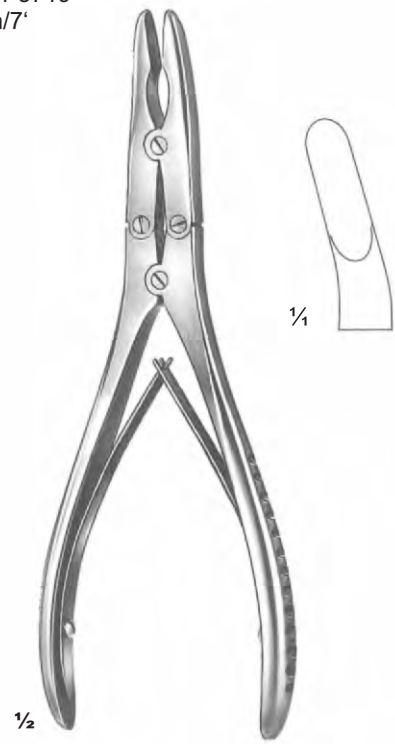

Ruskin
GM 74-3722
19 cm/7 3/4"

75

EN Forceps

DE Zange

ES Fórceps

Page 194 to 201

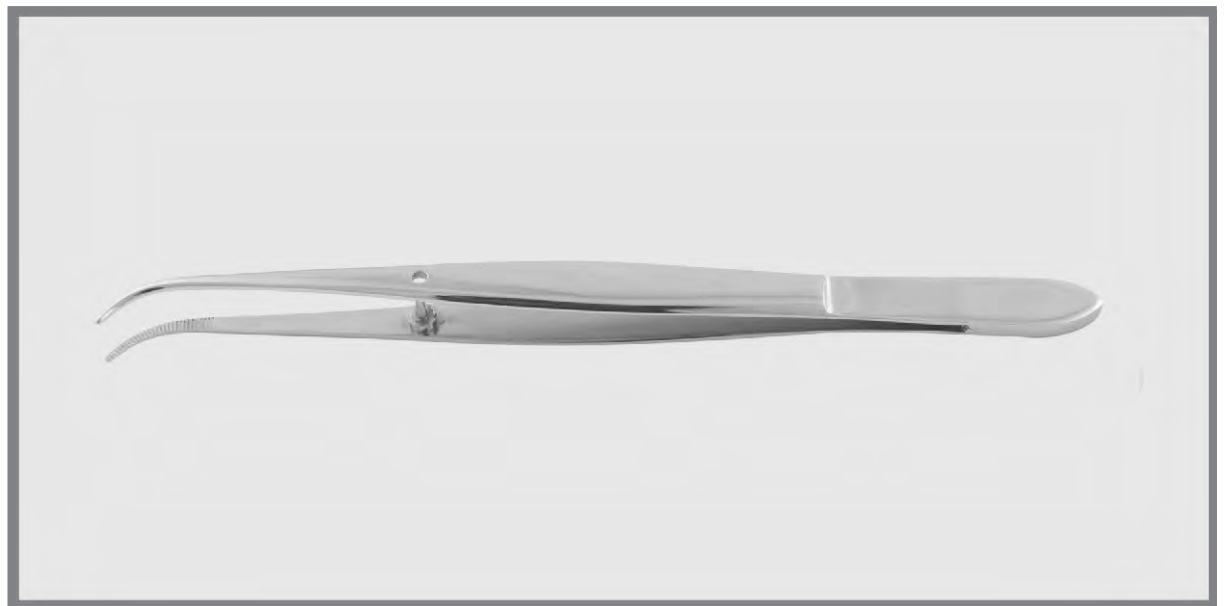



1/2

standard pattern

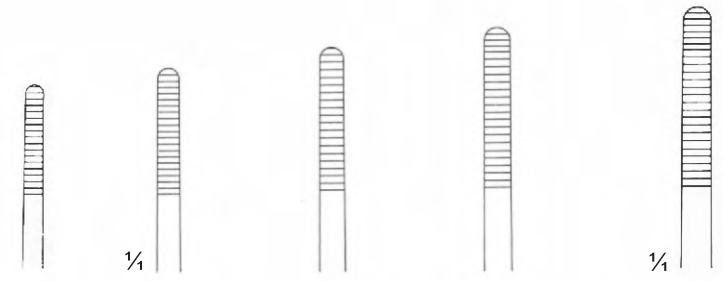

- GM 75-3801
13 cm/5 1/8"
- GM 75-3802
14.5 cm/5 3/4"
- GM 75-3803
16 cm/5 F
- GM 75-3804
18 cm/7"
- GM 75-3805
20 cm/7 X"



1/2

slender pattern

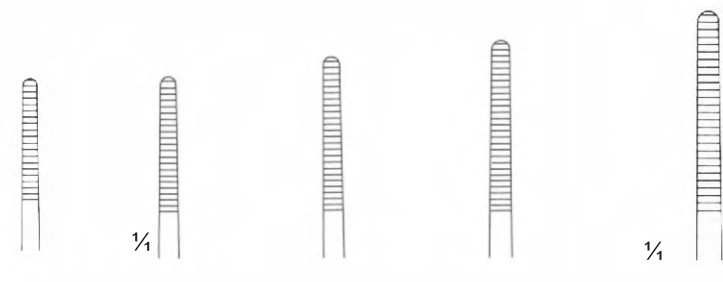

- GM 75-3806
13 cm/5 1/8"
- GM 75-3807
14.5 cm/5 3/4"
- GM 75-3808
16 cm/5 F
- GM 75-3809
18 cm/7"
- GM 75-3810
20 cm/7 X"

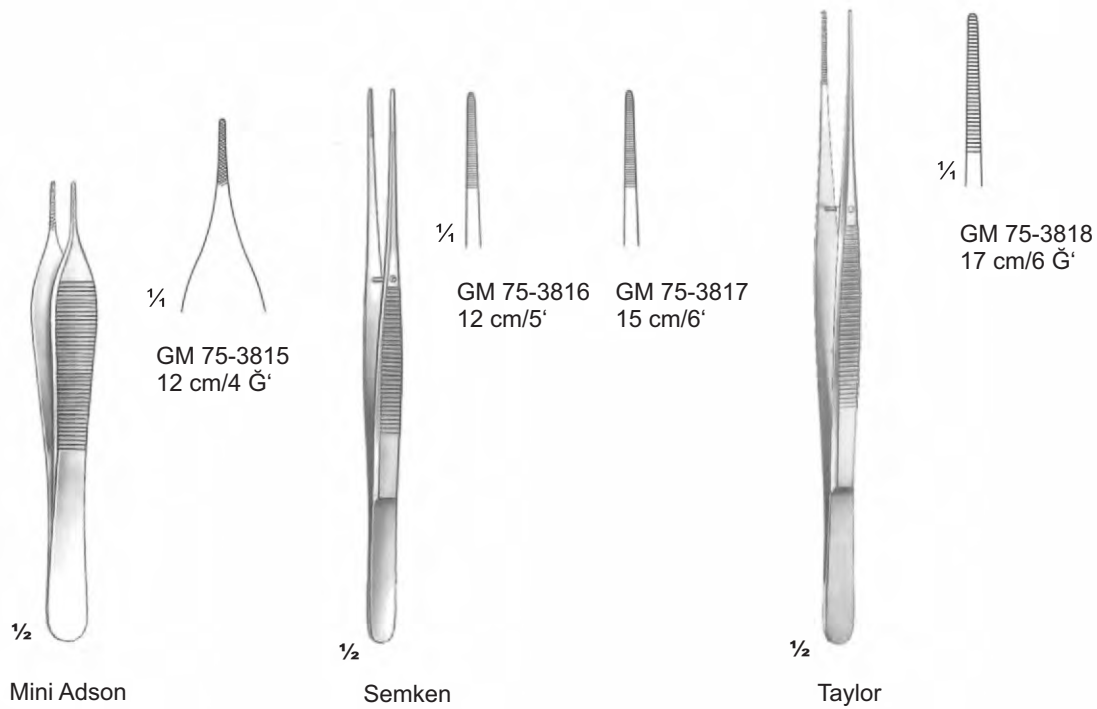
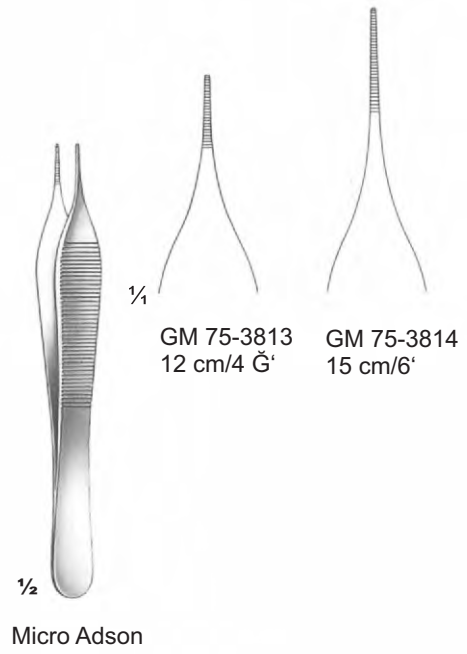
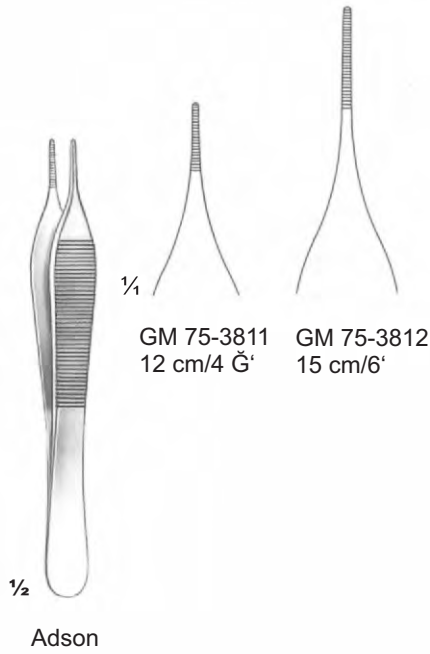

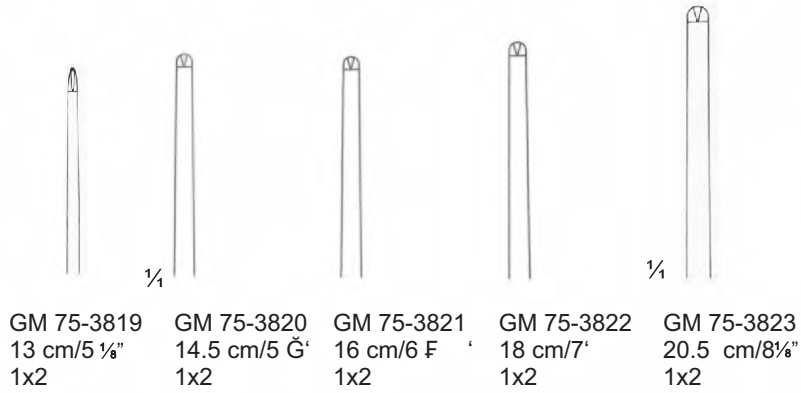

GM 75-3819 13 cm/5 1/8" 1x2	GM 75-3820 14.5 cm/5 3/4" 1x2	GM 75-3821 16 cm/6 F 1x2	GM 75-3822 18 cm/7" 1x2	GM 75-3823 20.5 cm/8 1/8" 1x2
-----------------------------------	-------------------------------------	--------------------------------	-------------------------------	-------------------------------------

Standard Pattern



GM 75-3824 13 cm/5 1/8" 1x2	GM 75-3825 14.5 cm/5 3/4" 1x2	GM 75-3826 16 cm/6 F 1x2	GM 75-3827 18 cm/7" 1x2	GM 75-3828 20.5 cm/8 1/8" 1x2
-----------------------------------	-------------------------------------	--------------------------------	-------------------------------	-------------------------------------

Slender Pattern

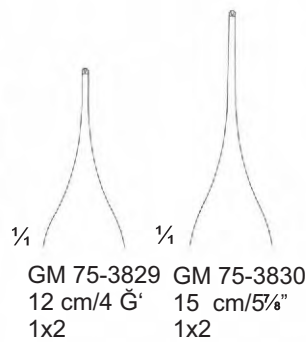

GM 75-3829 12 cm/4 3/4" 1x2	GM 75-3830 15 cm/5 7/8" 1x2
-----------------------------------	-----------------------------------

Adson

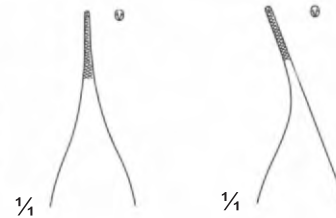

GM 75-3831 12 cm/4 3/4" 1x2	GM 75-3832 12 cm/4 3/4" 1x2
-----------------------------------	-----------------------------------

Mini Adson



Mikro Adson

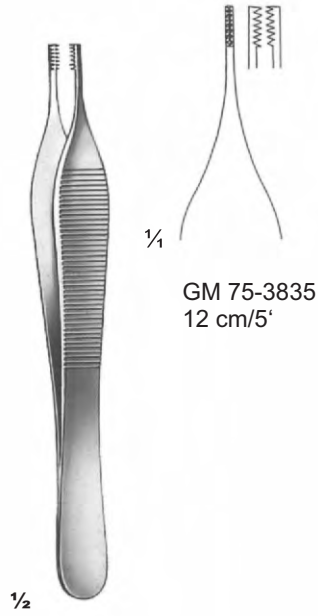
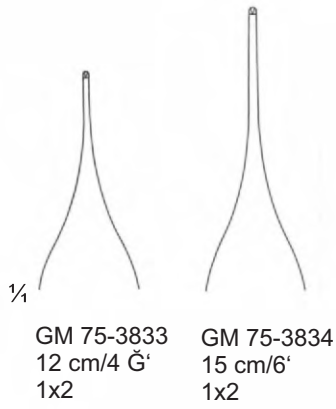

Adson-Brown



Semken

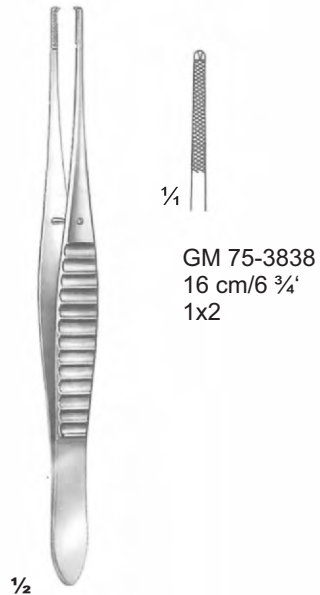
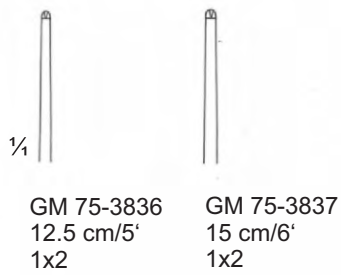

Gillies





DeBakey
12 cm/5"



GM 75-3852
2,7 mm



GM 75-3853
1,5 mm



GM 75-3854
2,0 mm



GM 75-3855
2,0 mm

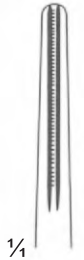

GM 75-3856
3,5 mm



Crane-Kaplan
Pocket marking forceps
15 cm/6"



GM 75-3857
No. 1

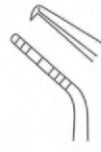

GM 75-3858
No. 2



Meriam
16 cm/6 F



GM 75-3859
No. 1



GM 75-3860
No. 3



GM 75-3861
No. 5



Flagg
16 cm/6 F



GM 75-3862
No. 1



GM 75-3863
No. 2



GM 75-3864
No. 3



GM 75-3865
No. 4



Standard

GM 75-3866 TC
 14.5 cm/5 3/4"

GM 75-3867 TC
 18 cm/7"



delicate

GM 75-3868 TC
 14.5 cm/5 3/4"

GM 75-3869 TC
 18 cm/7"



1/2

Adson



GM 75-3870 TC GM 75-3871 TC
 12 cm/4 3/4" 15 cm/6"
 1x2 1x2

mini profile



1/2

Gillies
 GM 75-3872 TC
 15.5 cm/6"
 1x2

mini profile



1/2

DeBakey
 GM 75-3873 TC
 16 cm/6 1/4"

ATRAUMA

micro profile





1/4
 C-079-15
 15 cm/6"

suited to hold silver pins, nerve-broaches
 and for introducing medicines



1/2
 Frigz
 Suture and membrane forceps

D = 1,6 mm



1/4
 GM 75-3839
 16 cm/6 F

D = 2,2 mm



1/4
 GM 75-3840
 16 cm/6 F



1/2
 Frigz



1/4
 GM 75-3841
 16 cm/6 F



1/2
 London-College
 15 cm/6"

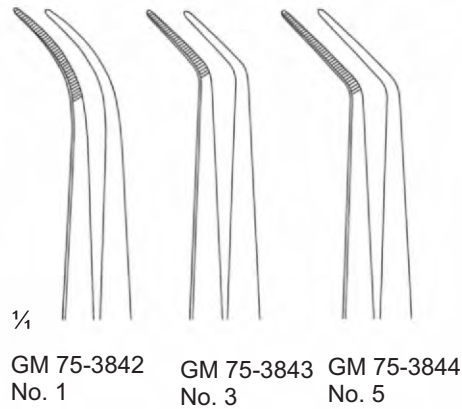

1/4
 GM 75-3842 No. 1
 GM 75-3843 No. 3
 GM 75-3844 No. 5



1/2
 London-College
 with lock
 15 cm/6"

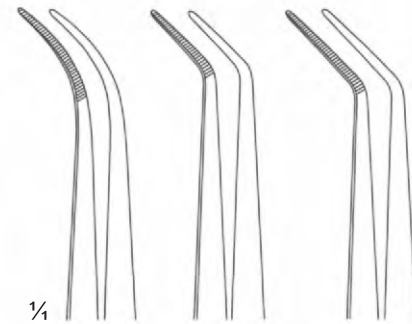

1/4
 GM 75-3845 No. 1
 GM 75-3846 No. 3
 GM 75-3847 No. 5

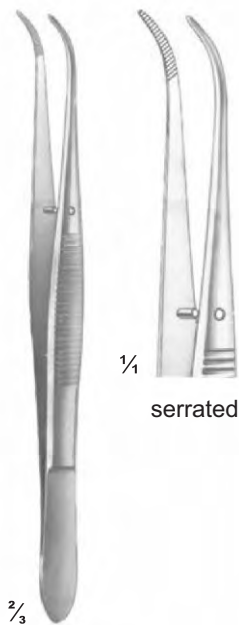

Perry
 GM 75-3848
 13 cm/5'

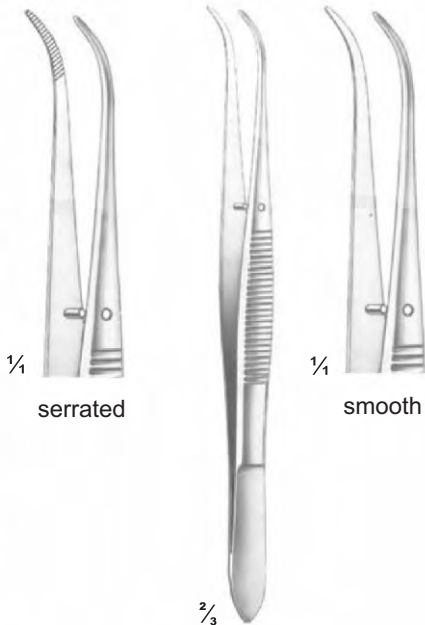

Perry
 GM 75-3849
 13 cm/5'

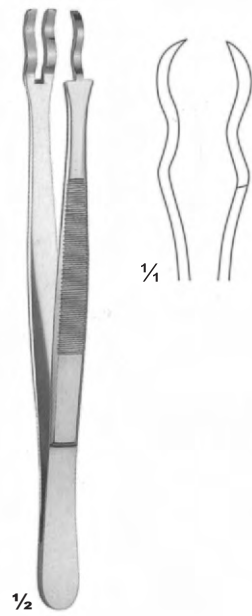

GM 75-3850
 14.5 cm/5.7"
 Frigz
 Grasping and
 sterilizing forceps

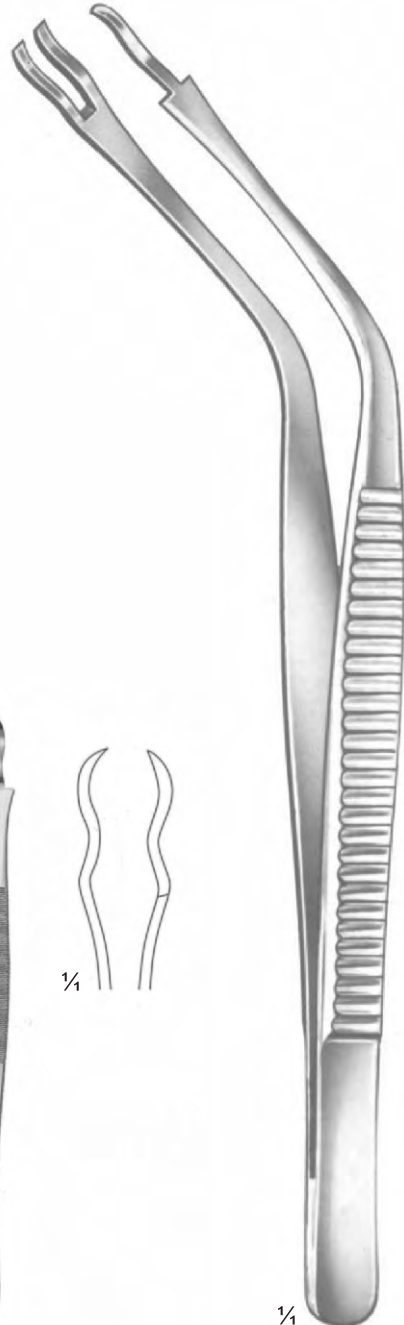

GM 75-3851
 20 cm/8"
 Seizing and
 Sterilizing Forceps



76

- EN** Scalpel Handles
- DE** Skalpellgriffe
- ES** Manches de bistouris

Page 202 to 203

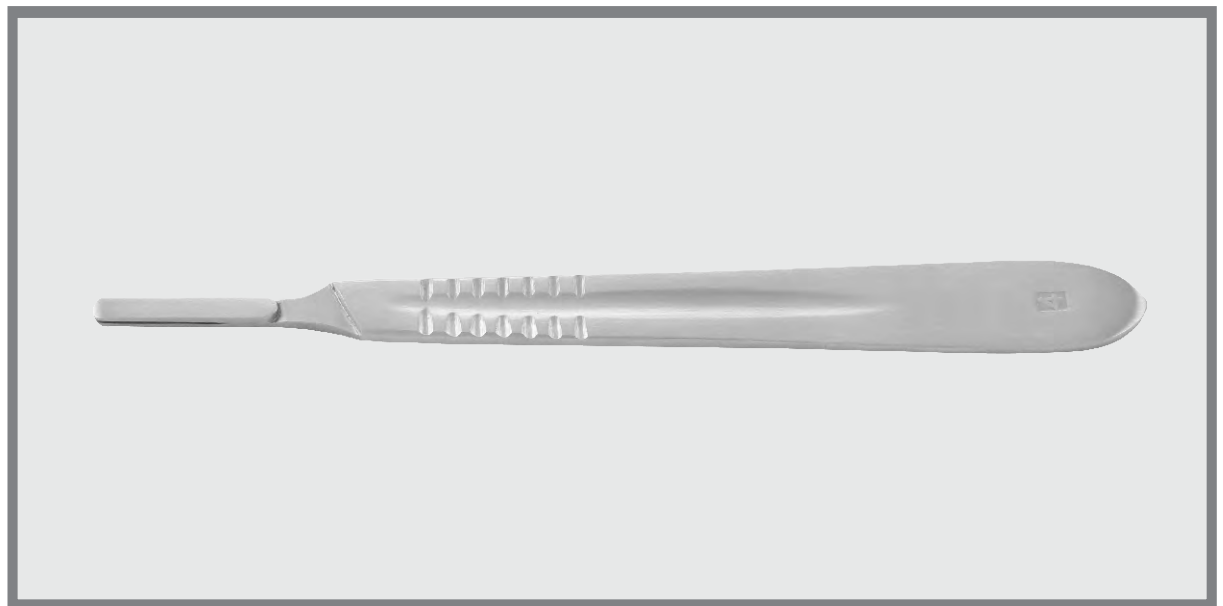



Standard
 GM 76-3901
 # 3



GM 76-3902
 # 3



GM 76-3903
 # 3
 with scale



GM 76-3904-3L # 3L
 GM 76-3905-3XL # 3XL



GM 76-3906-3L # 3L
 GM 76-3907-3XL # 3XL
 angled



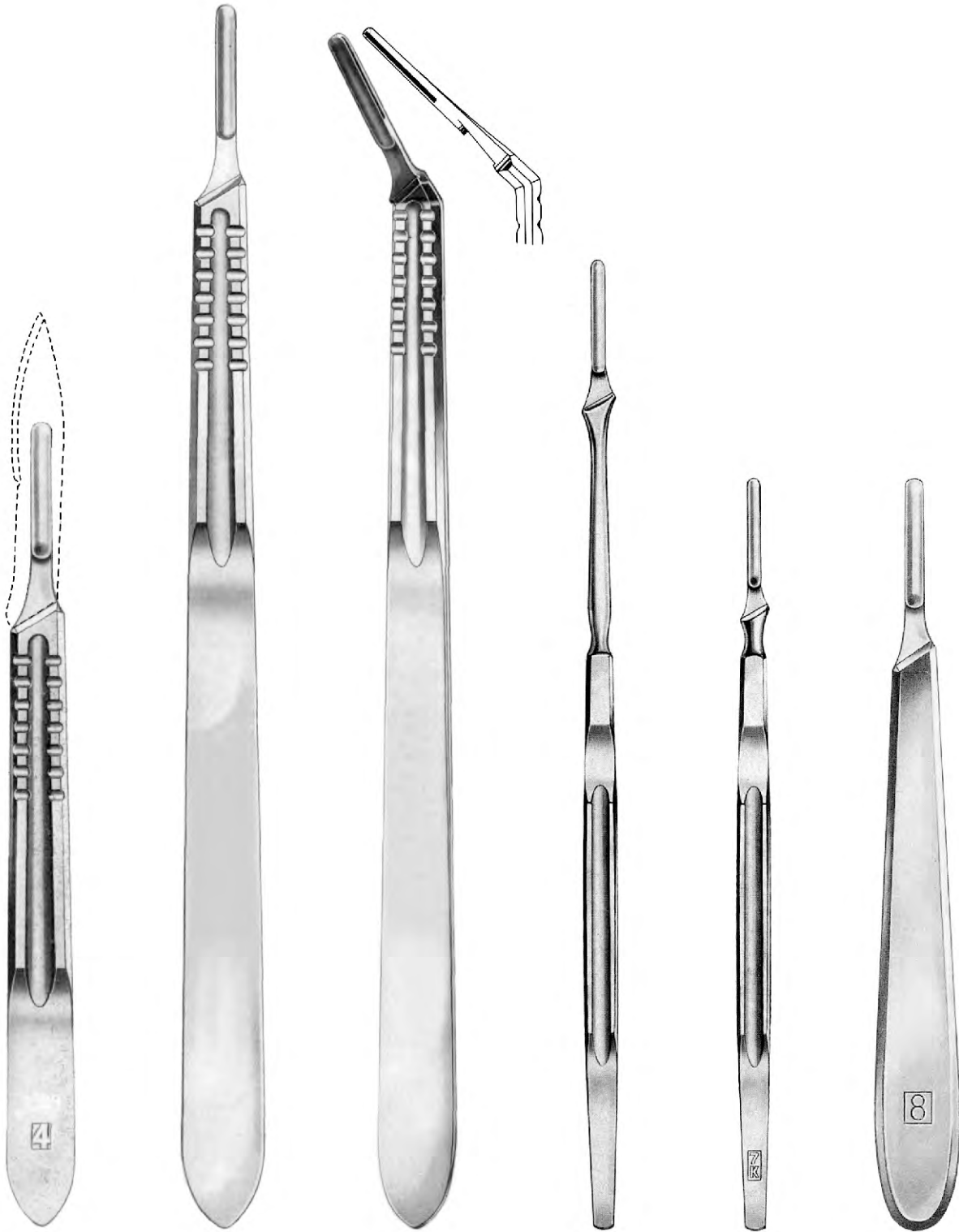

Standard
 GM 76-3908 # 4

GM 76-3909-4L # 4L GM 76-3911-4L # 4L
 GM 76-3910-4XL # 4XL GM 76-3912-4XL # 4XL
 angled

GM 76-3913 # 7

GM 76-3914 # 7K

Collin
 GM 76-3915 Fig. 8

77

- EN** Mallets
- DE** Schlägel
- ES** Mazos

Page 204 to 206

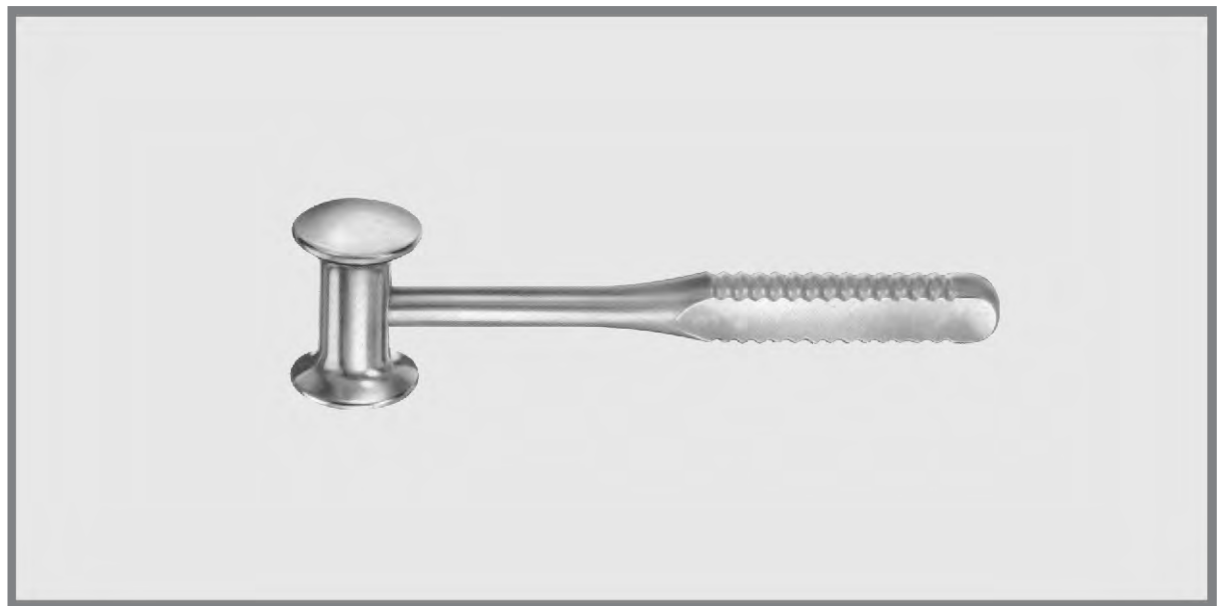



BERGMANN
GM 77-3951
24 cm/9 1/2"
300 grams



WILLIGER
24 cm/9 1/2"
lead filled

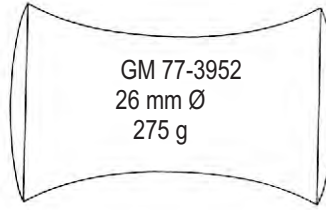

GM 77-3952
26 mm Ø
275 g

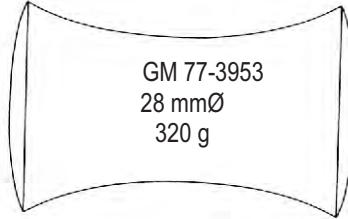

GM 77-3953
28 mm Ø
320 g

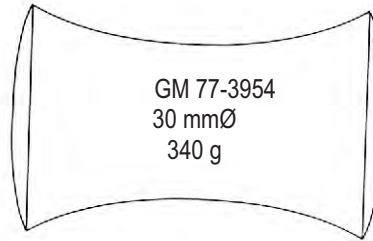

GM 77-3954
30 mm Ø
340 g



Ø 27 mm
300 g

PARTSCH
GM 77-3955
18 cm/7 1/8"
with hollow handle



DOYEN
21 cm/8 1/4"

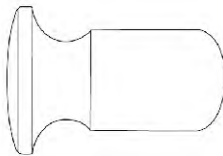

GM 77-3956
25 mm Ø
120 g (4 1/4 oz.)
19.5 cm/7 3/4"

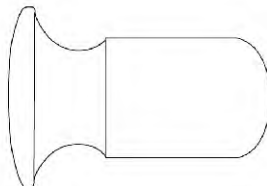

GM 77-3957
30 mm Ø
180 g (6 1/2 oz.)
19.5 cm/7 3/4"

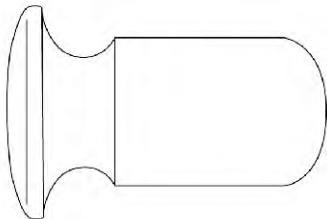

GM 77-3958
35 mm Ø
260 g (9 oz.)
21 cm/8 1/4"



27 mm Ø
300 g

with interchangeable plastic disks

MEAD
GM 77-3959 19 cm/7 1/2"
GM 77-3960 pair of spare disks





HAJEK
 GM 77-3961
 20 cm/7⁷/₈"
 200 g
 Ø 27 mm



KIRK
 GM 77-3962
 21 cm/8¹/₄"
 650 g
 Ø 38 mm



BERGMANN
 GM 77-3963
 24.5 cm/9⁵/₈"
 400 g
 Ø 30 mm



HEATH
 GM 77-3964
 18.5 cm/7¹/₄"
 700 g
 Ø 40 mm



with interchangeable
 disks
 GM 77-3965

GM 77-3965
 18.5 cm/7¹/₄"
 240 g
 Ø 25 mm



OMBREDANNE
 GM 77-3967
 24 cm/9¹/₂"
 700 g
 Ø 40 mm





GM 77-3968
 26.5 cm/10 3/8"
 Ø 50 mm
 1300 g

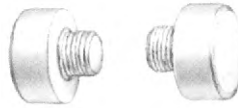

GM 77-3969
 spare facings (pair)



GM 77-3970
 19 cm/7 1/2"
 Ø 25 mm
 300 g



HERBERT
GM 77-3971
 19 cm/7 1/2"
 Ø 25 mm
 215 g



78

- EN** Cassettes
- DE** Kassetten
- ES** Cassettes

Page 207 to 210





Elongated Holes

Dimension(mm)

GM 78-400105-Instruments	78 x 182 x 32
GM 78-400210-Instruments	142 x 182 x 32
GM 78-400320-Instruments	270 x 182 x 32



Round Bottom with Strip Lock

Dimension(mm)

GM 78-400405-Instruments	90 x 182 x 25
GM 78-400510-Instruments	145 x 182 x 25
GM 78-400620-Instruments	270 x 182 x 25



Square

Dimension(mm)

GM 78-4007 05-Instruments	180 x 70 x 22
GM 78-4008 10-Instruments	180 x 130 x 22
GM 78-4009 20-Instruments	260 x 180 x 22

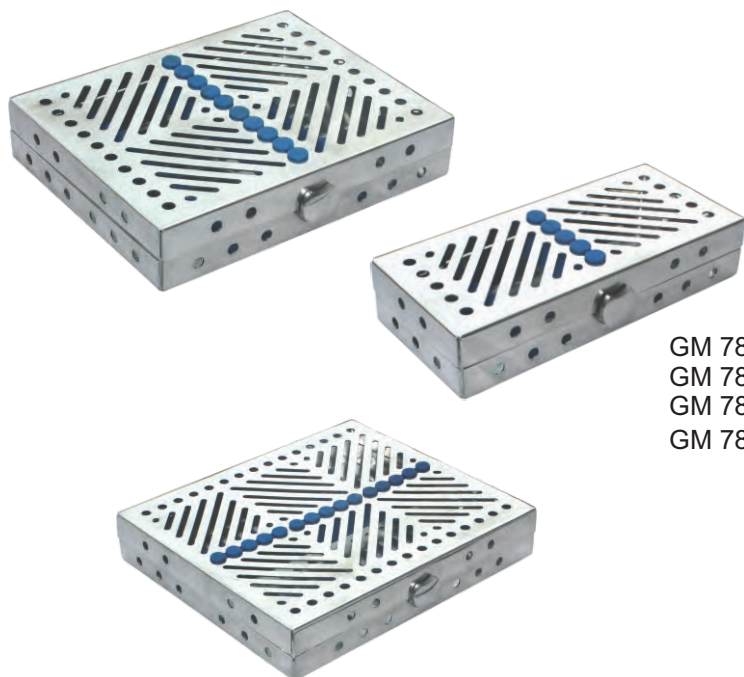

Elongated Holes

Dimension(mm)

GM 78-401005-Instruments	180 x 80 x 35
GM 78-401110-Instruments	180 x 145 x 35
GM 78-401215-Instruments	210 x 180 x 35
GM 78-401320-Instruments	280 x 180 x 35

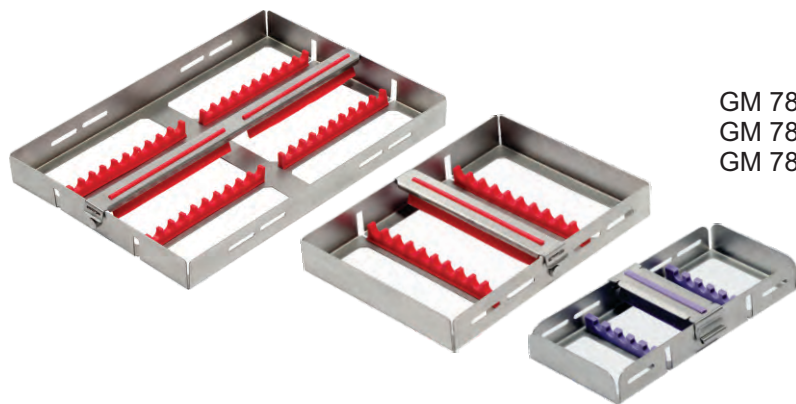

Strip Lock "H" Type

Model Dimension(mm)

GM 78-401405-Instruments	180 x 80 x 25
GM 78-401510-Instruments	180 x 130 x 25
GM 78-401620-Instruments	260 x 180 x 25

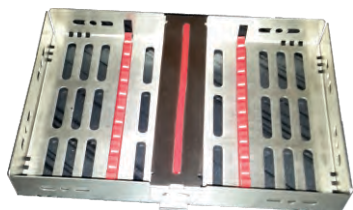

Strip Lock

Model Dimension(mm)

GM 78-401705-Instruments	180 x 80 x 25
GM 78-401810-Instruments	180 x 130 x 25
GM 78-401920-Instruments	260 x 180 x 25





Dimension(mm)

GM 78-4020	405 x 255 x 50
GM 78-4021	405 x 255 x 70
GM 78-4022	405 x 255 x 100



Dimension(mm)

GM 78-4023	255 x 245 x 50
GM 78-4024	255 x 245 x 70
GM 78-4025	255 x 245 x 100



Dimension(mm)

GM 78-4026	255 x 120 x 50
GM 78-4027	255 x 120 x 70

LIDs (optional)

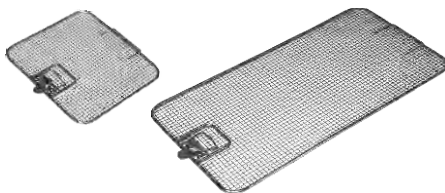

Dimension(mm)

GM 78-4028	255 x 120
GM 78-4029	255 x 245
GM 78-4030	250 x 240
GM 78-4031	540 x 255
GM 78-4032	485 x 255
GM 78-4033	405 x 255
GM 78-4034	480 x 370
GM 78-4035	480 x 250

Endoscopic Baskets

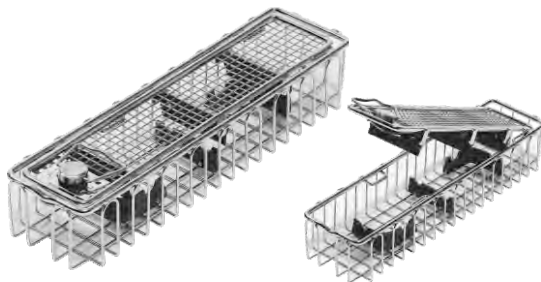

Dimension(mm)

GM 78-4036	290 x 80 x 52
GM 78-4037	460 x 80 x 52

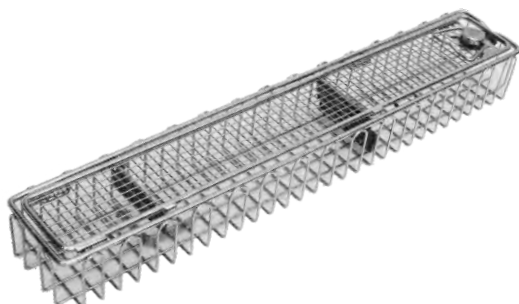

Dimension(mm)

GM 78-4038	670 x 80 x 52
GM 78-4039	700 x 80 x 52

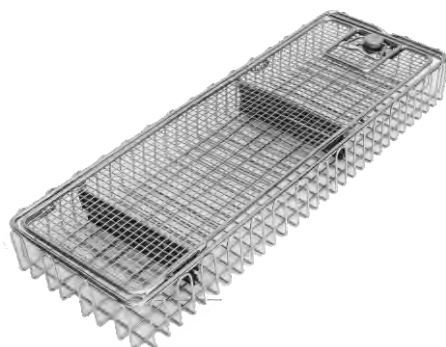

Dimension(mm)

GM 78-4040	290 x 160 x 52
GM 78-4041	310 x 150 x 77
GM 78-4042	460 x 160 x 77
GM 78-4043	640 x 150 x 77
GM 78-4044	660 x 150 x 77
GM 78-4045	460 x 160 x 52
GM 78-4046	580 x 160 x 52

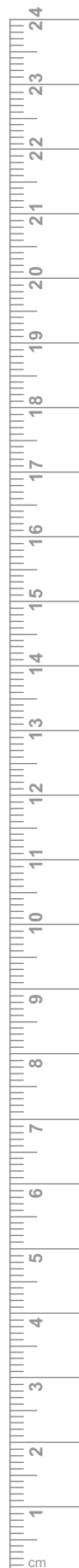

79

- EN** Cylinder cartidge syringe
- DE** Zylinder-Ampullenspritze
- ES** Seringue á ampoule cilindrique

Page 211 to 216

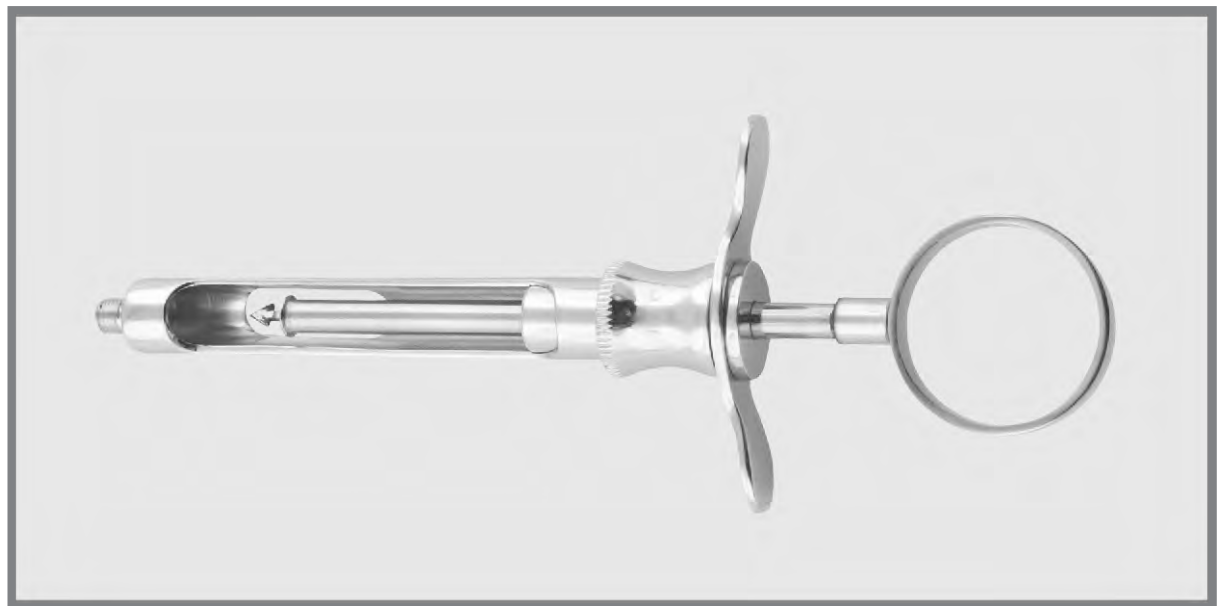



GM 79-4101
 Cylinder cartridge syringe
 1.8 cc, without aspiration
 metric thread / US Thread

GM 79-4103
 Cylinder cartridge syringe
 2.2 cc, without aspiration
 metric thread / US Thread



GM 79-4102
 Cylinder cartridge syringe
 1.8 cc, with aspiration
 metric thread / US Thread

GM 79-4104
 Cylinder cartridge syringe
 2.2 cc, with aspiration
 metric thread / US Thread

GM 79-4105
 Cylinder cartridge syringe
 1.8 cc, without aspiration with
 metric thread / US Thread

GM 79-4107
 Cylinder cartridge syringe
 2.2 cc, without aspiration with
 metric thread / US Thread

GM 79-4106
 Cylinder cartridge syringe
 1.8 cc, with aspiration with
 metric thread / US Thread

GM 79-4108
 Cylinder cartridge syringe
 2.2 cc, with aspiration with
 metric thread / US Thread



GM 79-4109

Cylinder cartridge syringe
 1.8 cc, without aspiration
 metric thread / US Thread

GM 79-4111

Cylinder cartridge syringe
 2.2 cc, without aspiration
 metric thread / US Thread

GM 79-4110

Cylinder cartridge syringe
 1.8 cc, with aspiration
 metric thread / US Thread

GM 79-4112

Cylinder cartridge syringe
 2.2 cc, with aspiration
 metric thread / US Thread



GM 79-4113

Cylinder Cartridge Syringe
 1.8cc without Aspiration
 metric thread / US Thread

GM 79-4115

Cylinder Cartridge Syringe
 2.2cc without Aspiration
 metric thread / US Thread

GM 79-4114

Cylinder Cartridge Syringe
 1.8cc with Aspiration
 metric thread / US Thread

GM 79-4116

Cylinder Cartridge Syringe
 2.2cc with Aspiration
 metric thread / US Thread





GM 79-4117
 Cylinder Cartridge Syringe
 1.8cc without Aspiration
 metric thread / US Thread
 Plastic base & handle sand blast
 finish steel rod.

GM 79-4119
 Cylinder Cartridge Syringe
 2.2cc without Aspiration
 metric thread / US Thread
 Plastic base & handle sand blast
 finish steel rod.

GM 79-4118
 Cylinder Cartridge Syringe
 1.8cc with Aspiration
 metric thread / US Thread
 Plastic base & handle sand blast
 finish steel rod.

GM 79-4120
 Cylinder Cartridge Syringe
 2.2cc with Aspiration
 metric thread / US Thread
 Plastic base & handle sand blast
 finish steel rod.



GM 79-4121
 Cylinder Cartridge Syringe
 1.8cc without Aspiration
 metric thread / US Thread

GM 79-4123
 Cylinder Cartridge Syringe
 2.2cc without Aspiration
 metric thread / US Thread

GM 79-4122
 Cylinder Cartridge Syringe
 1.8cc with Aspiration
 metric thread / US Thread

GM 79-4124
 Cylinder Cartridge Syringe
 2.2cc with Aspiration
 metric thread / US Thread



GM 79-4125
 Cylinder Cartridge Syringe
 1.8cc without Aspiration
 metric thread / US Thread

GM 79-4126
 Cylinder Cartridge Syringe
 1.8cc with Aspiration
 metric thread / US Thread

GM 79-4127
 Cylinder Cartridge Syringe
 2.2cc without Aspiration
 metric thread / US Thread

GM 79-4128
 Cylinder Cartridge Syringe
 2.2cc with Aspiration
 metric thread / US Thread



GM 79-4129
 Cylinder Cartridge Syringe
 1.8cc without Aspiration
 metric thread / US Thread

GM 79-4130
 Cylinder Cartridge Syringe
 1.8cc with Aspiration
 metric thread / US Thread

GM 79-4131
 Cylinder Cartridge Syringe
 2.2cc without Aspiration
 metric thread / US Thread

GM 79-4132
 Cylinder Cartridge Syringe
 2.2cc with Aspiration
 metric thread / US Thread





GM 79-4133
 Cylinder Cartridge Syringe
 1.8cc without Aspiration
 metric thread / US Thread

GM 79-4135
 Cylinder Cartridge Syringe
 2.2cc without Aspiration
 metric thread / US Thread

GM 79-4134
 Cylinder Cartridge Syringe
 1.8cc with Aspiration
 metric thread / US Thread

GM 79-4136
 Cylinder Cartridge Syringe
 2.2cc with Aspiration
 metric thread / US Thread



GM 79-4137
 Aspirating Syringe
 1.8cc with fix tip, S/S
 metric thread / US Thread

GM 79-4138
 Aspirating Syringe
 2.2cc with fix tip, S/S
 metric thread / US Thread

Intra-Ligamentale Syringes

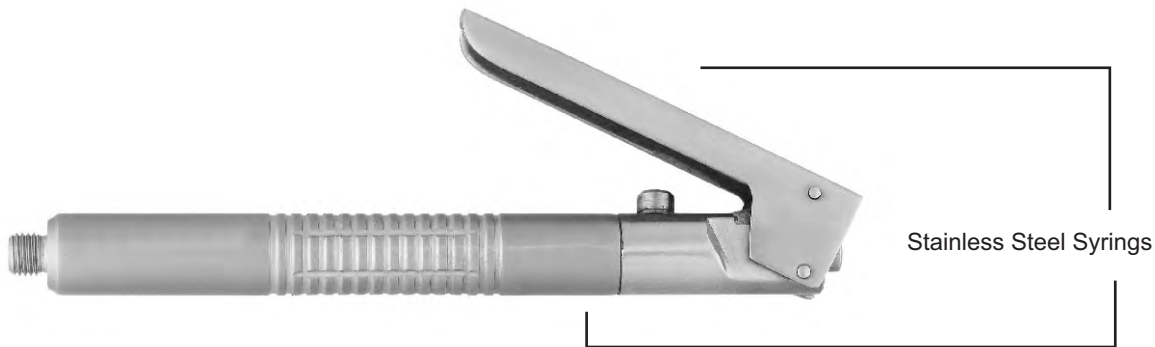

GM 79-4139
 1.8 cc metric thread / US Thread
 2.2 cc metric thread / US Thread

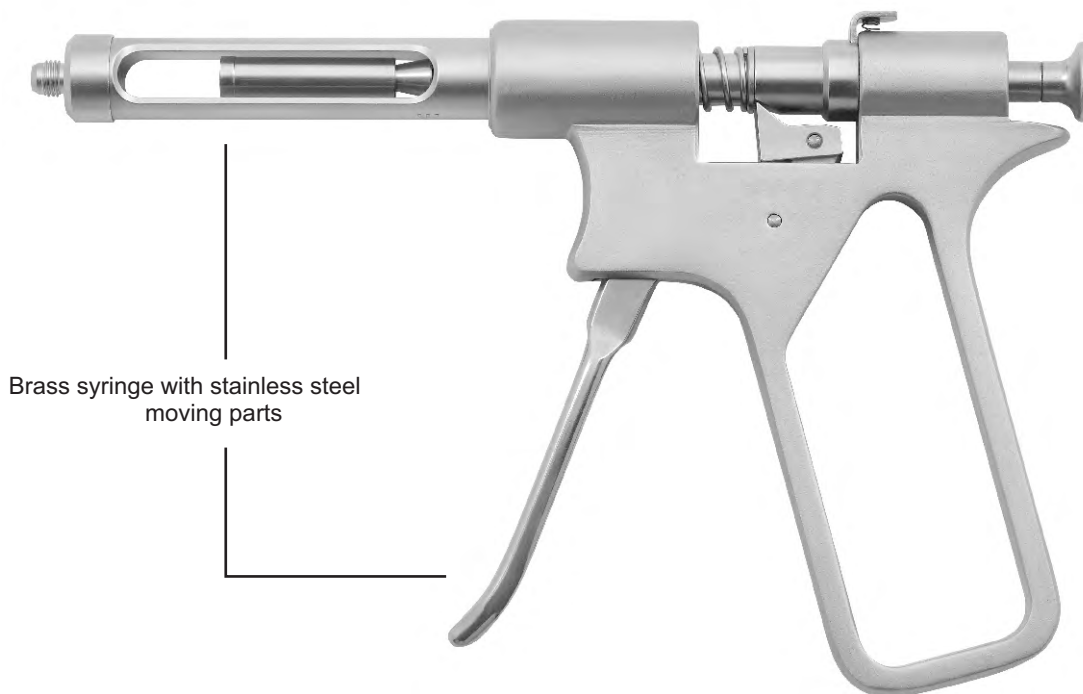

GM 79-4140
 1.8 cc metric thread / US Thread
 2.2 cc metric thread / US Thread



80

- EN** Impression Trays
- DE** Abdrucklöffel
- ES** Porte empreintes

Page 217 to 228

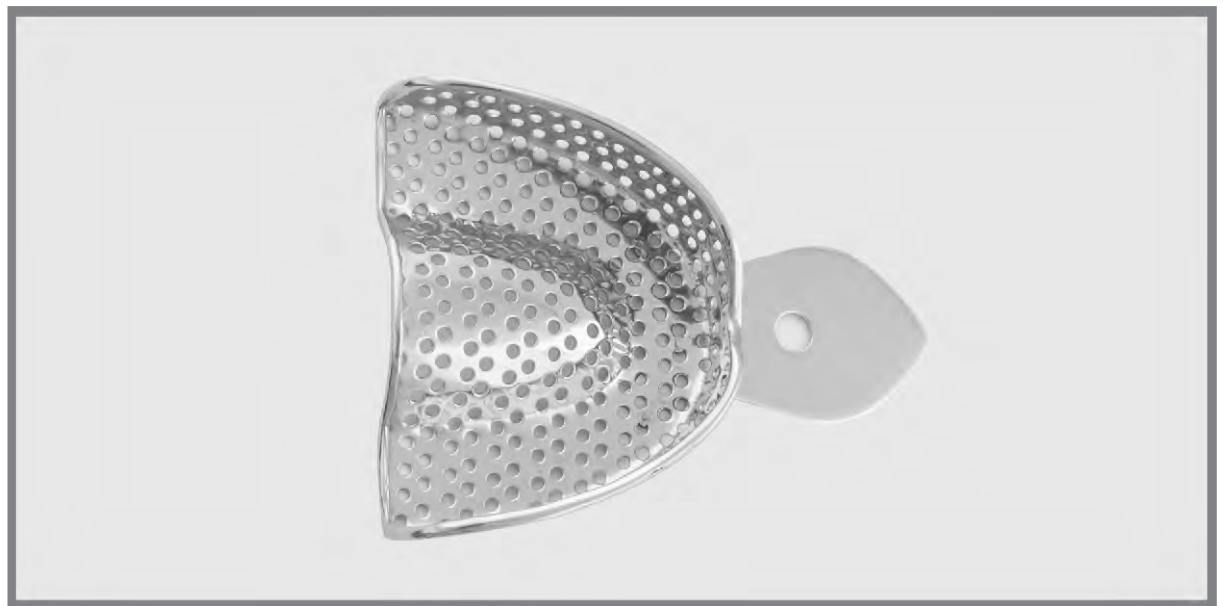

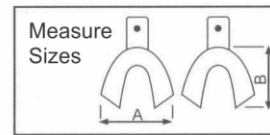
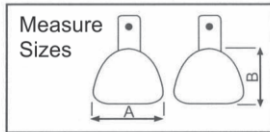
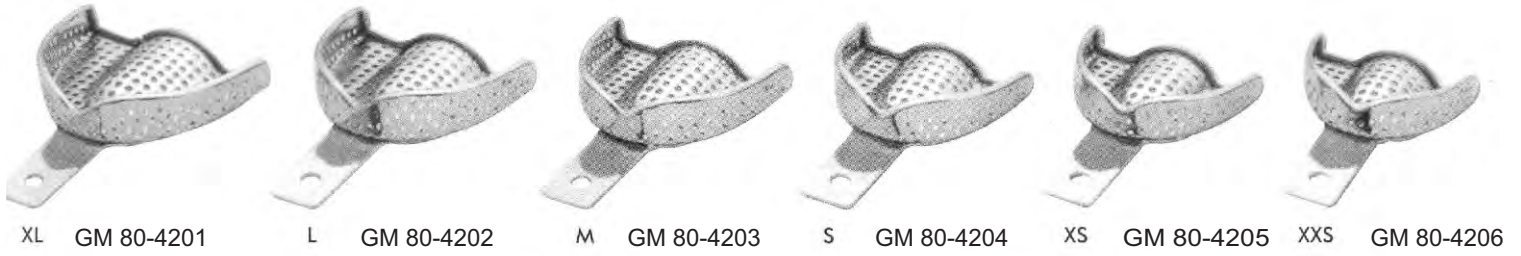

Upper		A (left-right)	B (top-bottom)
80-4201	XL	81 mm	63 mm
80-4202	L	73 mm	58 mm
80-4203	M	71 mm	52 mm
80-4204	S	67 mm	53 mm
80-4205	XS	65 mm	51 mm
80-4206	XXS	61 mm	50 mm

Lower		A (left-right)	B (top-bottom)
80-4207	XL	78 mm	63 mm
80-4208	L	74 mm	62 mm
80-4209	M	72 mm	59 mm
80-4210	S	70 mm	57 mm
80-4211	XS	69 mm	55 mm
80-4212	XXS	59 mm	50 mm

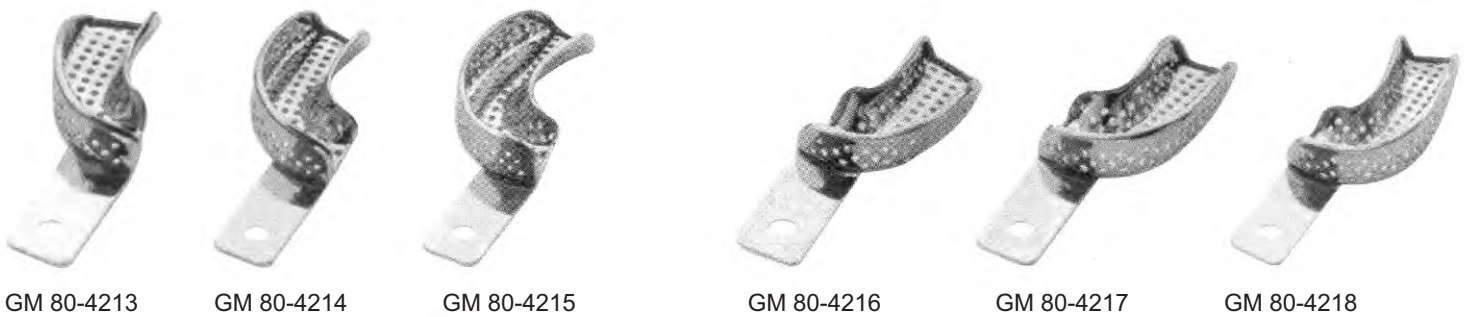
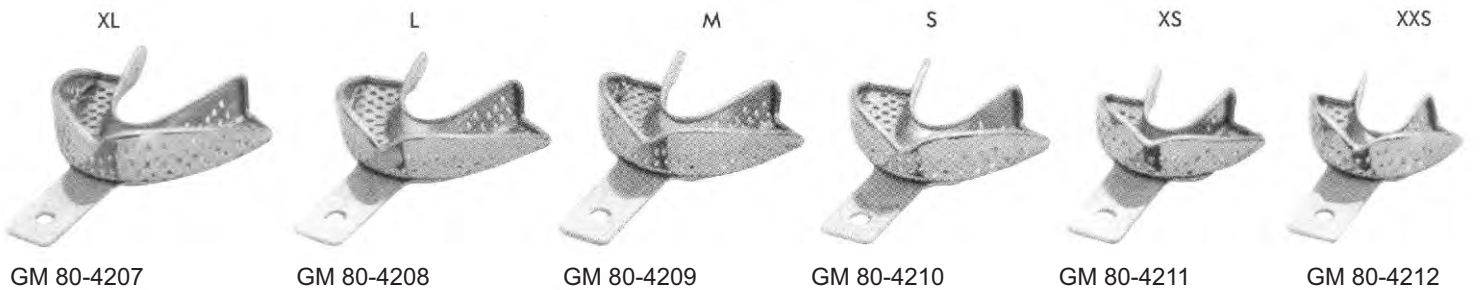

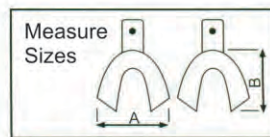
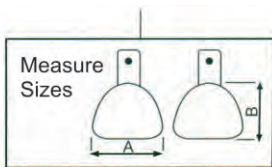
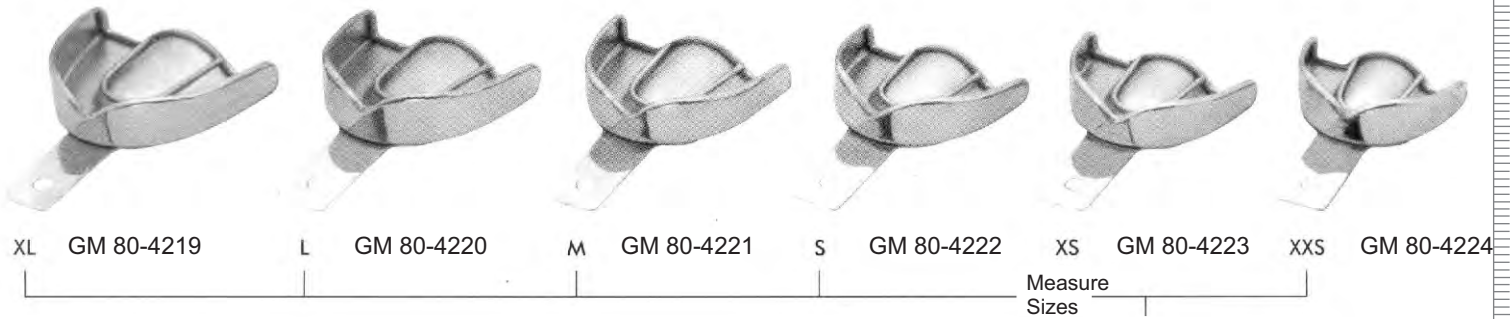

Upper		A (left-right)	B (top-bottom)
81-4219	XL	81 mm	63 mm
81-4220	L	73 mm	58 mm
81-4221	M	71 mm	52 mm
81-4222	S	67 mm	53 mm
81-4223	XS	65 mm	51 mm
81-4224	XXS	61 mm	50 mm

Lower		A (left-right)	B (top-bottom)
81-4225	XL	78 mm	63 mm
81-4226	L	74 mm	62 mm
81-4227	M	72 mm	59 mm
81-4228	S	70 mm	57 mm
81-4229	XS	69 mm	55 mm
81-4201	XXS	59 mm	50 mm

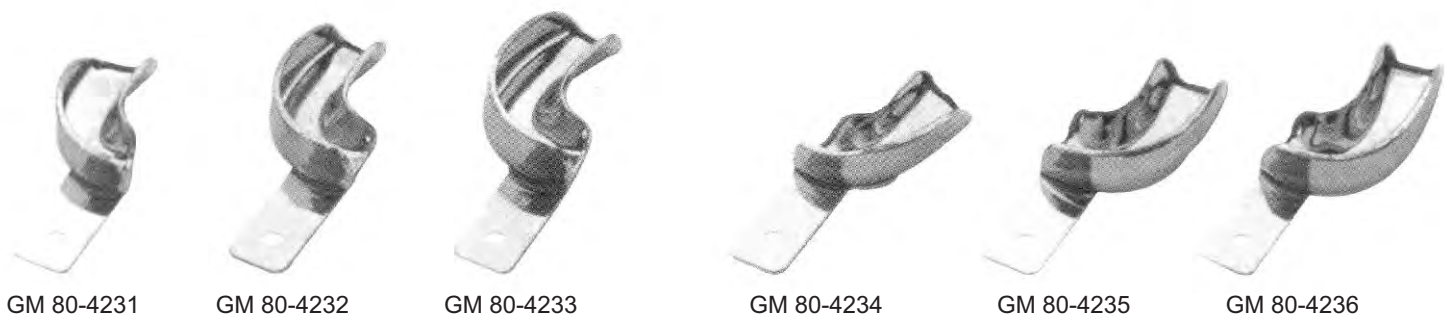
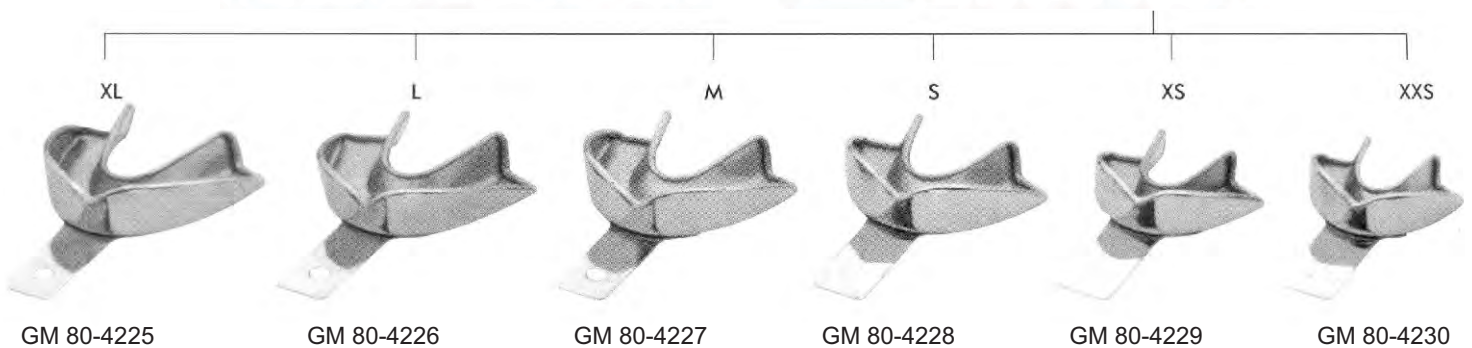

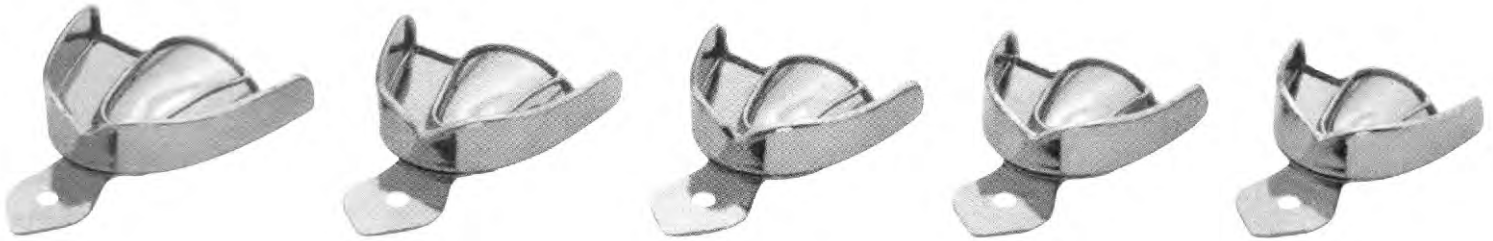

GM 80-4237

GM 80-4238

GM 80-4239

GM 80-4240

GM 80-4241

XL

L

M

S

XS

Upper		A (left-right)	B (top-bottom)
GM 80-4237	XL	81 mm	63 mm
GM 80-4238	L	73 mm	58 mm
GM 80-4239	M	71 mm	52 mm
GM 80-4240	S	67 mm	53 mm
GM 80-4241	XS	65 mm	51 mm

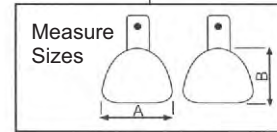

Lower		A (left-right)	B (top-bottom)
GM 80-4242	XL	78 mm	63 mm
GM 80-4243	L	74 mm	62 mm
GM 80-4244	M	72 mm	59 mm
GM 80-4245	S	70 mm	57 mm
GM 80-4246	XS	69 mm	55 mm

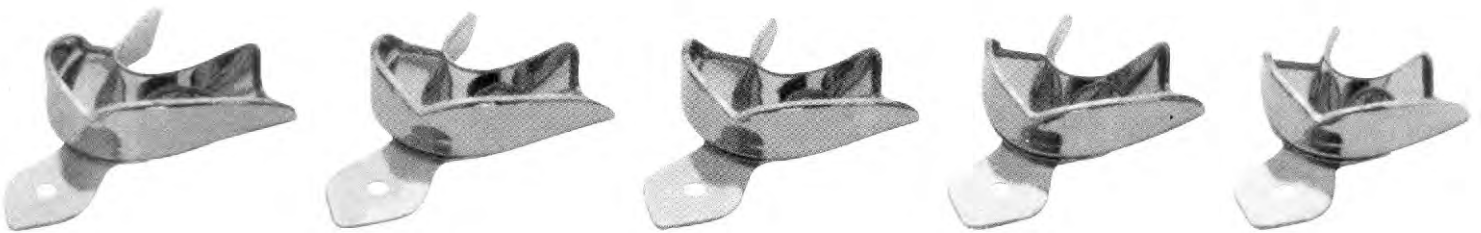
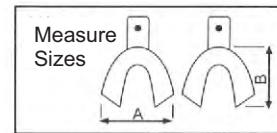

GM 80-4242

GM 80-4243

GM 80-4244

GM 80-4245

GM 80-4246

XL

L

M

S

XS

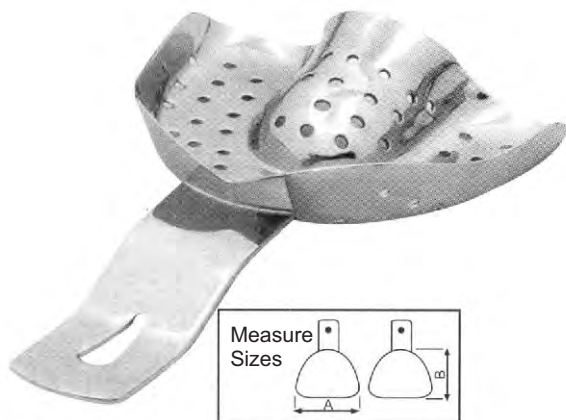

For Toothed Upper Jaws
 (Fig. 0 for children)

	A mm.	B mm.
GM 80-42470	59	52
GM 80-42481	66	52
GM 80-42492	71	62
GM 80-42503	71	64
GM 80-42514	80	70

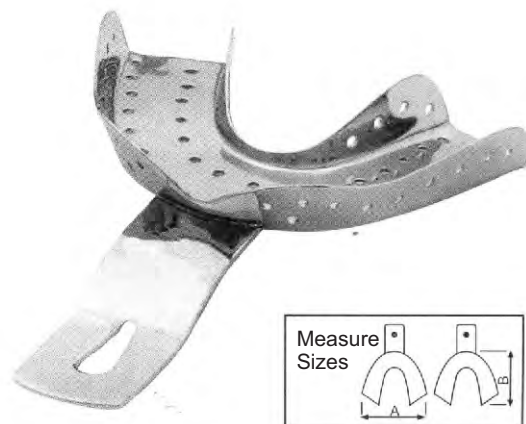

For Toothed Lower Jaws
 (Fig. 0 for children)

	A mm.	B mm.
GM 80-42520	65	46
GM 80-42531	67	50
GM 80-42542	76	54
GM 80-42553	79	56
GM 80-42564	79	61



For Narrow Toothed Upper Jaws

	A mm.	B mm.
GM 80-42572	70	54





For partially toothed upper jaws

	A mm.	B mm.
GM 80-4258 1	62	50
GM 80-42592	70	56

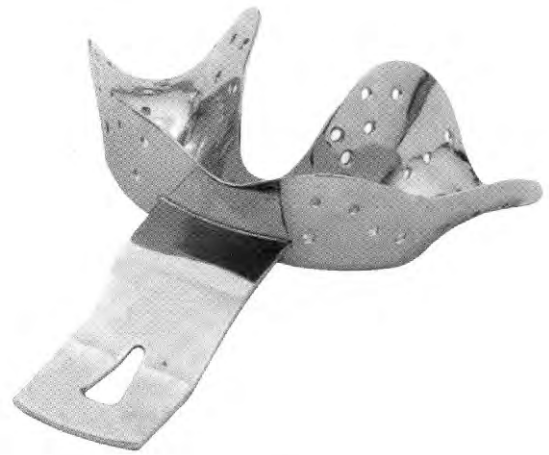
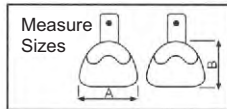

For partially toothed lower jaws

	A mm.	B mm.
GM 80-42601	70	55
GM 80-42612	78	59

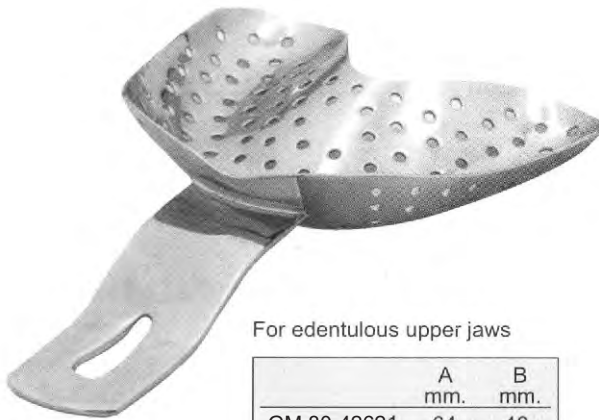
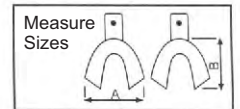

For edentulous upper jaws

	A mm.	B mm.
GM 80-42621	64	46
GM 80-42632	68	53
GM 80-42643	79	61

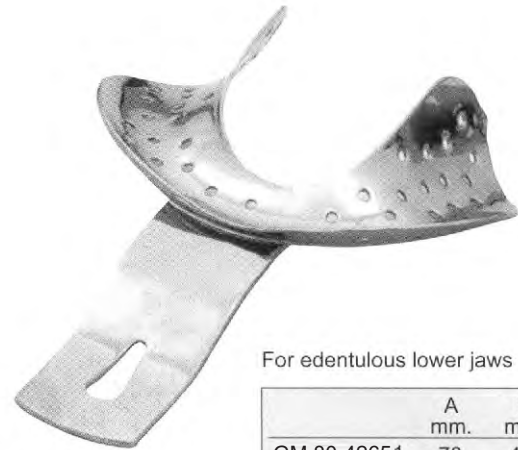

For edentulous lower jaws

	A mm.	B mm.
GM 80-42651	70	48
GM 80-42662	70	53
GM 80-42673	72	57



Solid stainless steel anterior depressed impression trays with retention rim.

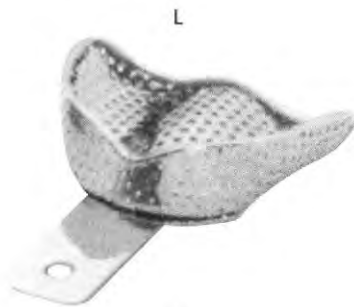
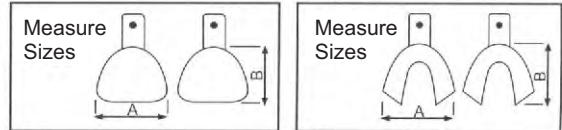

GM 80-4268

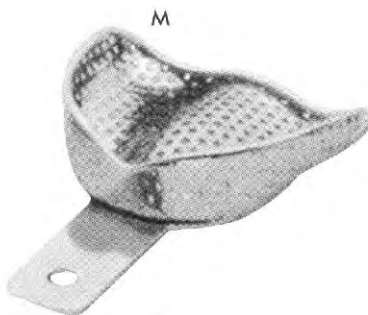

GM 80-4269

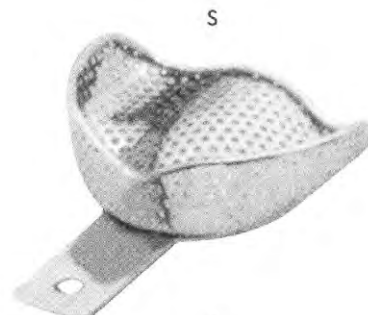

GM 80-4270



GM 80-4271

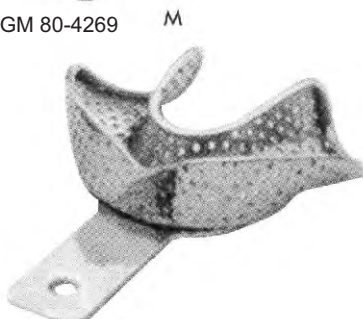

GM 80-4272



GM 80-4273

	A mm.	B mm.
GM 80-4268 L	81	67
GM 80-4269M	71	64
GM 80-4270 S	70	57

	A mm.	B mm.
GM 80-4271 L	81	60
GM 80-4272M	79	57
GM 80-4273 S	76	54



Solid total denture stainless steel impression trays with rim.

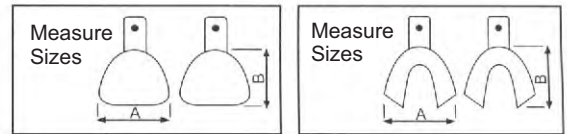

GM 80-4274

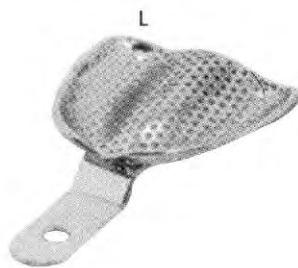

GM 80-4275

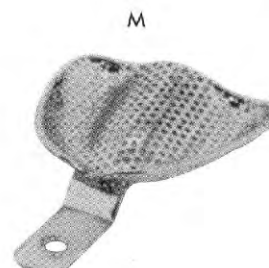

GM 80-4276

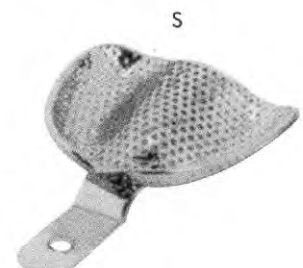

GM 80-4277



GM 80-4278

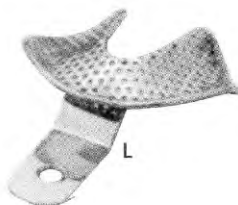

GM 80-4279

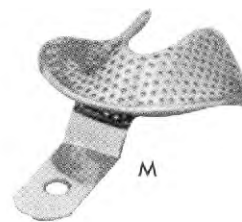

GM 80-42GM 80

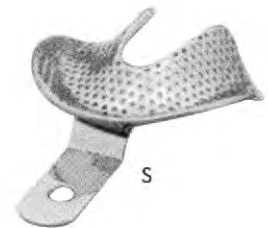

GM 80-4281

	A mm.	B mm.
GM 80-4274 XL	79	70
GM 80-4275 L	76	67
GM 80-4276 M	70	64
GM 80-4277 S	73	60

	A mm.	B mm.
GM 80-4278 XL	86	64
GM 80-4279 L	70	64
GM 80-42GM 80	73	60
GM 80-4281 S	70	57



Solid stainless steel anterior depressed impression trays with retention rim.

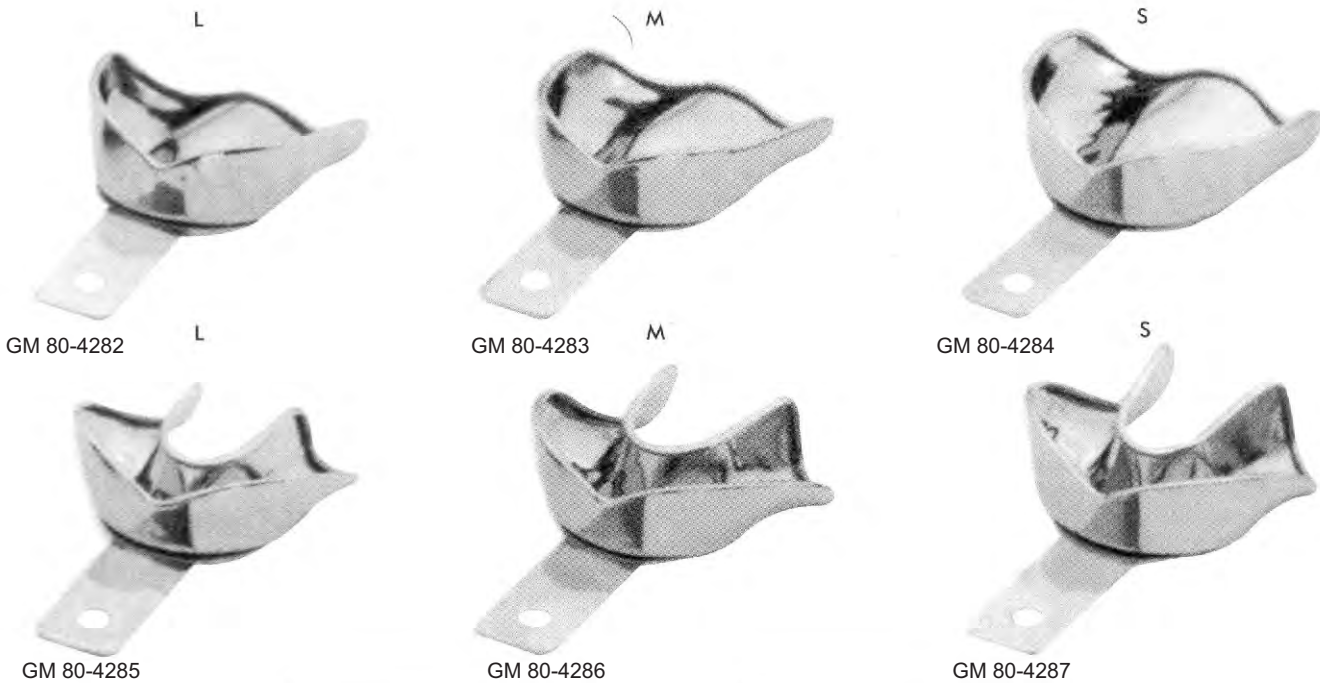
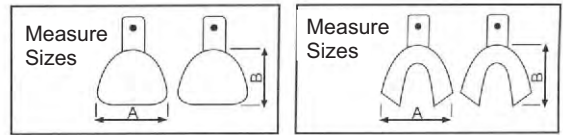

GM 80-4282 L

GM 80-4283 M

GM 80-4284 S

GM 80-4285 L

GM 80-4286 M

GM 80-4287 S

	A	B
	mm.	mm.
GM 80-4282 L	81	67
GM 80-4283 M	71	64
GM 80-4284 S	70	57

	A	B
	mm.	mm.
GM 80-4285 L	81	60
GM 80-4286 M	79	57
GM 80-4287 S	76	54



Solid total denture stainless steel impression trays with rim.

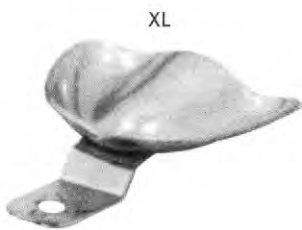
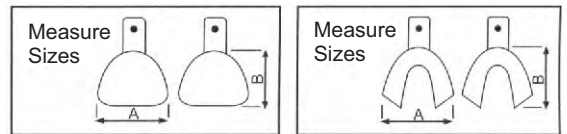

GM 80-4288

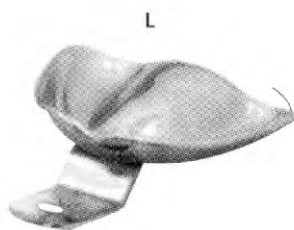

GM 80-4289

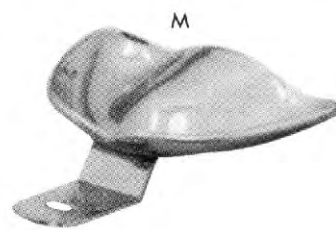

GM 80-4290

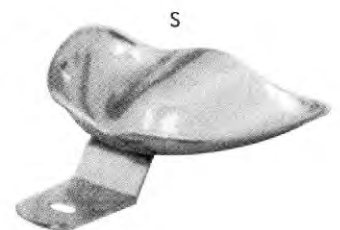

GM 80-4291



GM 80-4292



GM 80-4293

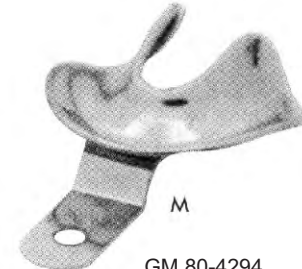

GM 80-4294



GM 80-4295

	A mm.	B mm.
GM 80-4288 XL	79	70
GM 80-4289 L	76	67
GM 80-4290 M	70	64
GM 80-4291 S	73	60

	A mm.	B mm.
GM 80-4292 XL	86	64
GM 80-4293 L	70	64
GM 80-4294 M	73	60
GM 80-4295 S	70	57



U18

GM 80-4296



U17

GM 80-4297



U16

GM 80-4298



U15

GM 80-4299



L18
GM 80-4300

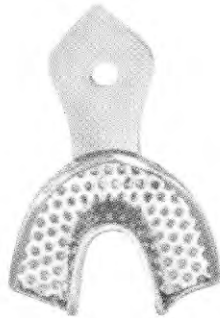

L17
GM 80-4301

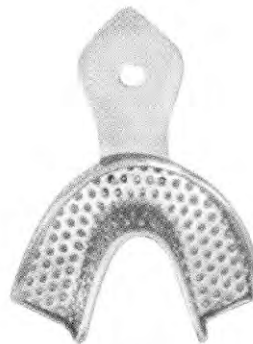

L16
GM 80-4302



L15
GM 80-4303



U24

GM 80-4304



U23

GM 80-4305



U22

GM 80-4306



U21

GM 80-4307



L24
GM 80-4308



L23
GM 80-4309



L22
GM 80-4310



L21
GM 80-4311



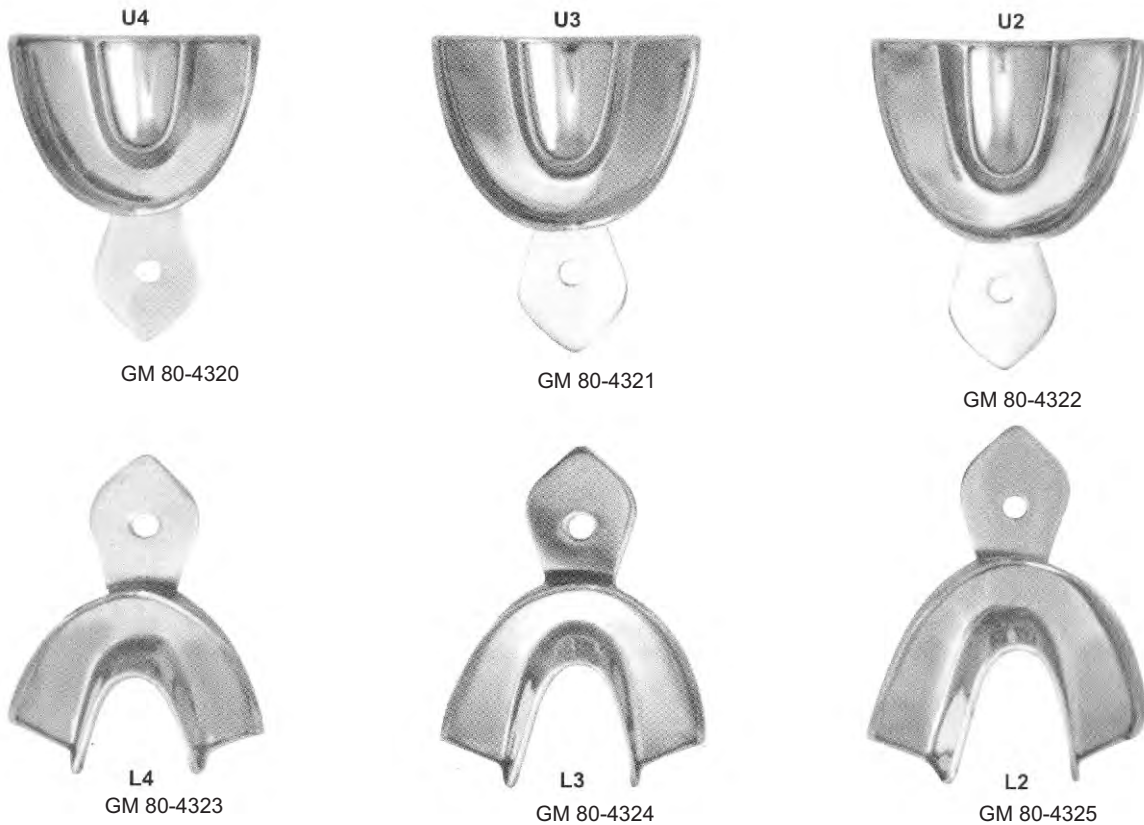
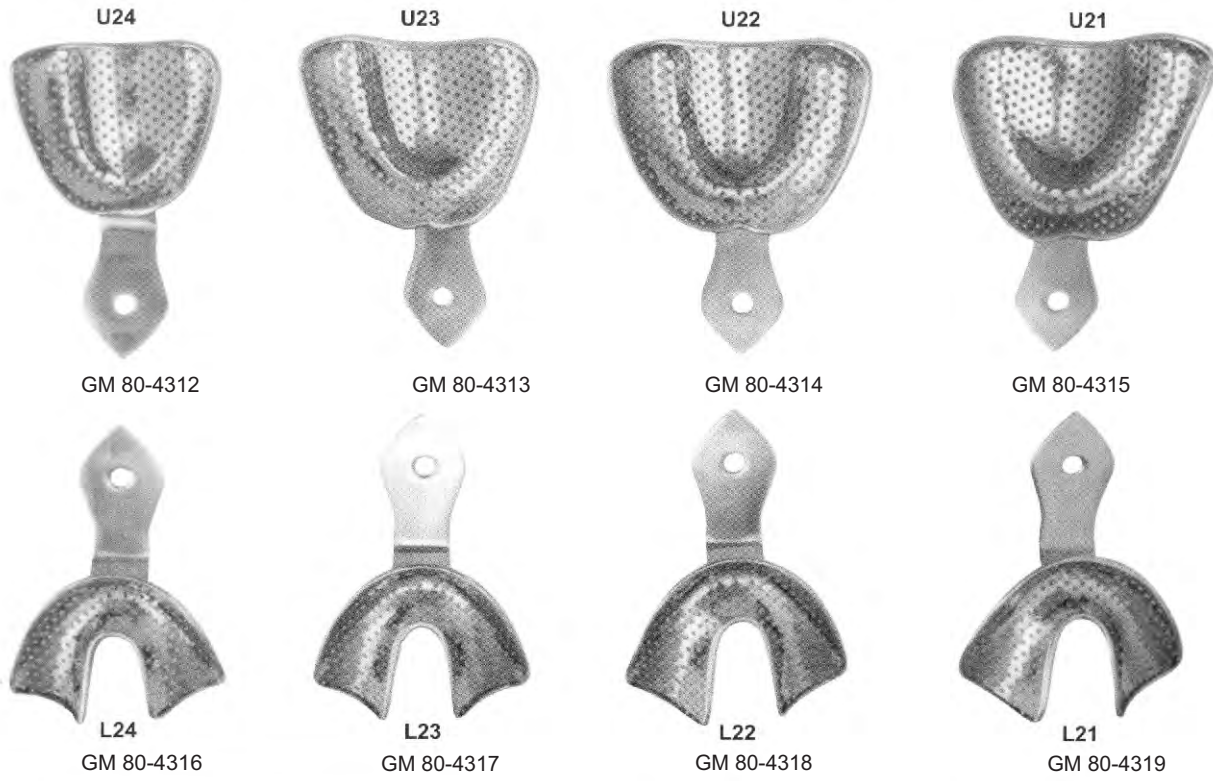

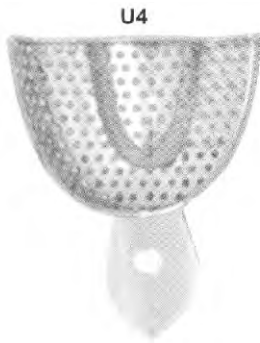

U4

GM 80-4326



U3

GM 80-4327



U2

GM 80-4328

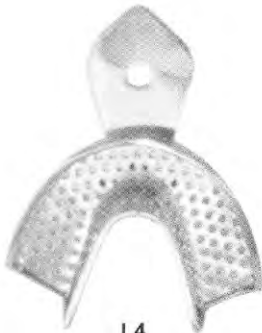

L4

GM 80-4329

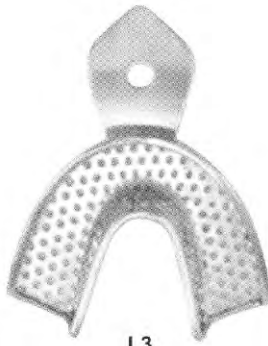

L3

GM 80-4330



L2

GM 80-4331



U15

GM 80-4332



U16

GM 80-4333



U17

GM 80-4334



U18

GM 80-4335



L15

GM 80-4336



L16

GM 80-4337

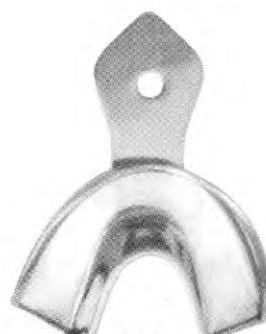

L17

GM 80-4338



L18

GM 80-4339



81

- EN** Articulators
- DE** Artikulatoren
- ES** Articuladores

Page 229 to 230





GM 81-4301



GM 81-4302



GM 81-4303



GM 81-4304



GM 81-4306



GM 81-4305

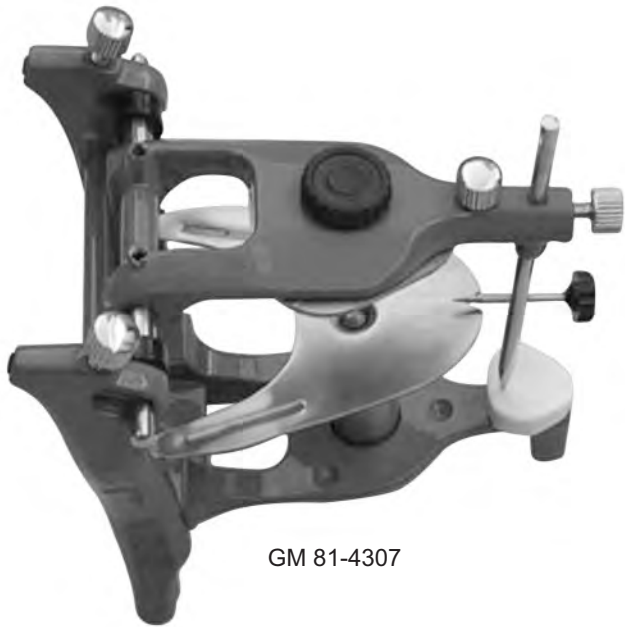

GM 81-4307



GM 81-4308



GM 81-4309



GM 81-4310



GM 81-4312



GM 81-4311

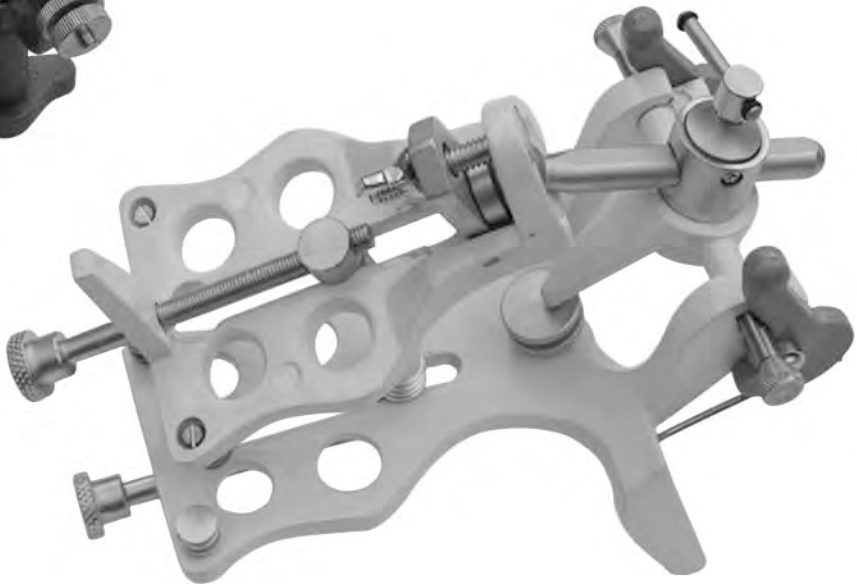

GM 81-4313



82

- EN** Holloware
- DE** Holloware
- ES** holloware

Page 231 to 234





Needle Case Round with Cover
 GM 82-4401 65x15mm



Needle Case Round
 GM 82-4402 80x20mm



Needle Case Rectangle
 GM 82-4403 70x70x10mm

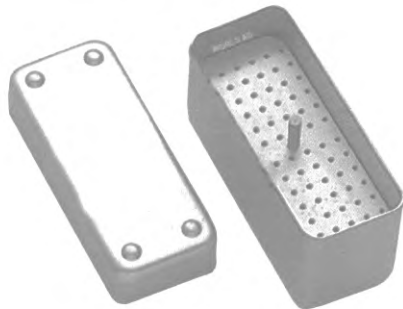

Endodontic Box
 GM 82-4404
 100x40x50mm



Tube Rack

GM 82-4405 6.35x15.25x5cm for 12 tubes
 GM 82-4406 6.35x17.75x7.5cm for 27 tubes
 GM 82-4407 7.50x17.75x6.35cm for 36 tubes



Sprit Lamp
 GM 82-4408
 Standard Size



Sprit Lamp
 GM 82-4409
 Standard Size



Sputum Cup

GM 82-4410 75x80mm
 GM 82-4411 100x50mm
 GM 82-4412 100x80mm



Dressing Jar

GM 82-4413 80x60mm
 GM 82-4414 80x80mm
 GM 82-4415 100x100mm
 GM 82-4416 120x120mm
 GM 82-4417 150x150mm
 GM 82-4418 180x180mm
 GM 82-4419 200x200mm

GM 82-4420
 GM 82-4421
 GM 82-4423
 GM 82-4424
 GM 82-4425
 GM 82-4426
 GM 82-4427



Dressing Jar



Fennle

GM 82-4428 100mm Ø
 GM 82-4429 120mm Ø
 GM 82-4430 150mm Ø
 GM 82-4431 200mm Ø



Cotton Holder
 GM 82-4432



Cotton Holder
 GM 82-4433





Forceps Jar

GM 82-4434 30x90mm
 GM 82-4435 50x125mm
 GM 82-4436 50x170mm
 GM 82-4437 50x200mm
 GM 82-4438 40x230mm
 GM 82-4439 70x110mm
 GM 82-4440 80x150mm
 GM 82-4441 100x200mm
 GM 82-4442 150x30mm



Medicine Cup

GM 82-4461 50ml
 GM 82-4462 60ml
 GM 82-4463 70ml



Kick Bucket with Trolley
 30-6819-01
 390x280x180mm

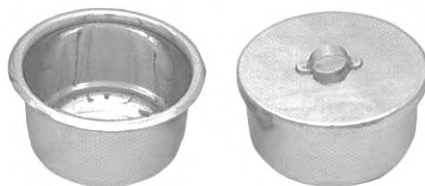

Gallipot

GM 82-4443 01 oz	GM 82-4450 09 oz
GM 82-4444 02 oz	GM 82-4451 10 oz
GM 82-4445 03 oz	GM 82-4452 11 oz
GM 82-4446 04 oz	GM 82-4453 12 oz
GM 82-4447 05 oz	GM 82-4454 13 oz
GM 82-4448 06 oz	GM 82-4455 14 oz
GM 82-4448 07 oz	GM 82-4456 15 oz
GM 82-4449 08 oz	GM 82-4457 16 oz



Sponge Bowl

GM 82-4458 12 cm
 GM 82-4459 15 cm
 GM 82-4460 20 cm



Lotion Bowl without spout

GM 82-4464 40x19mm	GM 82-4471 150x65mm
GM 82-4465 50x25mm	GM 82-4472 180x85mm
GM 82-4466 60x30mm	GM 82-4473 200x100mm
GM 82-4467 80x40mm	GM 82-4474 250x120mm
GM 82-4468 100x50mm	GM 82-4475-12 300mm
GM 82-4469 120x60mm	GM 82-4476-13 350mm
GM 82-4470 140x60mm	GM 82-4477-14 400mm



Wash Basin

GM 82-4478 300x80mm
 GM 82-4479 320x85mm
 GM 82-4480 330x90mm
 GM 82-4481 350x110mm
 GM 82-44GM 82 400x115mm



Kidney Tray

GM 82-4486 12cm
 GM 82-4487 15cm
 GM 82-4488 18cm
 GM 82-4489 20cm
 GM 82-4490 25cm
 GM 82-4491 28cm
 GM 82-4492 30cm



Kidney Tray Shallow

GM 82-4483 17cm
 GM 82-4484 22cm
 GM 82-4485 24cm



Kidney Tray (with cover)

GM 82-4493 15cm
 GM 82-4494 20cm
 GM 82-4495 25cm
 GM 82-4496 30cm

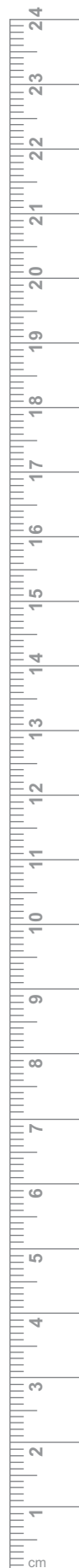

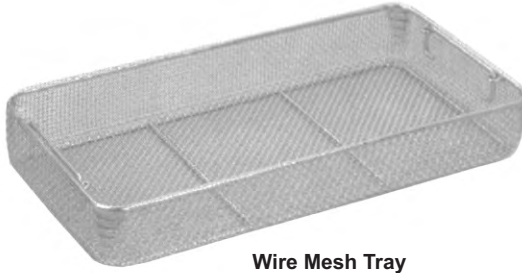

Wire Mesh Tray

- GM 82-4497 240x250x5mm
- GM 82-4498 480x250x5mm
- GM 82-4499 550x250x5mm
- GM 82-4500 240x250x7mm
- GM 82-4501 480x250x7mm
- GM 82-4502 240x250x10mm
- GM 82-4503 480x250x10mm

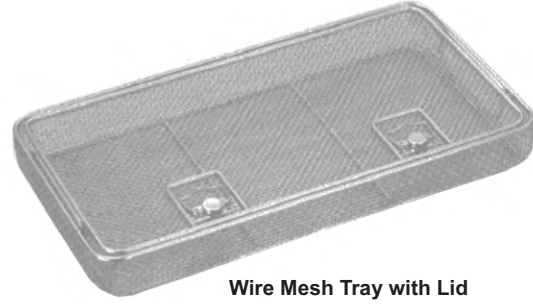

Wire Mesh Tray with Lid

- GM 82-4504 240x250x5mm
- GM 82-4505 480x250x5mm
- GM 82-4506 550x250x5mm
- GM 82-4507 240x250x7mm
- GM 82-4508 480x250x7mm
- GM 82-4509 240x250x10mm
- GM 82-4510 480x250x10mm



Perforated Tray

- GM 82-4511 200x100x40mm
- GM 82-4512 250x120x50mm
- GM 82-4513 300x150x50mm
- GM 82-4514 350x170x50mm
- GM 82-4515 400x200x50mm



Instruments Tray without Lid

- GM 82-4516 100x150x25mm
- GM 82-4517 150x200x40mm
- GM 82-4518 200x250x45mm
- GM 82-4519 250x300x50mm
- GM 82-4520 300x350x50mm
- GM 82-4521 150x300x50mm
- GM 82-4522 200x300x50mm
- GM 82-4523 230x150x50mm



Instruments Tray with Lid

- GM 82-4524 100x150x25mm
- GM 82-4525 150x200x40mm
- GM 82-4526 200x250x45mm
- GM 82-4527 250x300x50mm
- GM 82-4528 300x350x50mm
- GM 82-4529 150x300x50mm
- GM 82-4530 200x300x50mm
- GM 82-4531 230x150x50mm



Burr Tray

- GM 82-4532
190x100x20mm

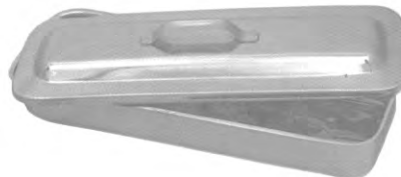

Cathetes Tray with Lid

- GM 82-4533 300x80x40mm
- GM 82-4534 350x90x45mm
- GM 82-4535 400x100x50mm

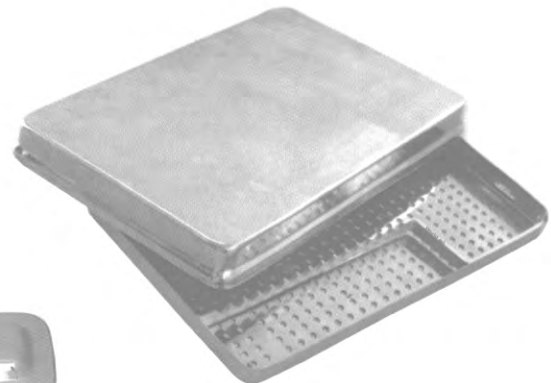

Scaler Tray with cover

- GM 82-4536
200x100x16mm





**Instruments Box
with Hooks**

- GM 82-4537 170x70x30mm
- GM 82-4538 180x80x40mm
- GM 82-4539 200x100x40mm
- GM 82-4540 230x120x50mm
- GM 82-4541 250x125x50mm
- GM 82-4542 300x150x50mm
- GM 82-4543 350x170x50mm
- GM 82-4544 400x200x90mm
- GM 82-4545 500x200x120mm



Instruments Box

- GM 82-4546 170x70x30mm
- GM 82-4547 180x80x40mm
- GM 82-4548 200x100x40mm
- GM 82-4549 230x120x50mm
- GM 82-4550 250x125x50mm
- GM 82-4551 300x150x50mm
- GM 82-4552 350x170x50mm
- GM 82-4553 400x200x90mm
- GM 82-4554 500x200x120mm



**Instruments Box
Perforated**

- GM 82-4555 200x100x40mm
- GM 82-4556 250x150x40mm
- GM 82-4557 300x150x40mm



Electric Sterilizer

- GM 82-4558 200x100x120mm
- GM 82-4559 250x120x140mm
- GM 82-4560 300x150x150mm
- GM 82-4561 350x170x170mm
- GM 82-4562 400x200x180mm
- GM 82-4563 450x230x190mm



Non Electric Sterilizer

- GM 82-4564 200x100x65mm
- GM 82-4565 250x125x65mm
- GM 82-4566 300x150x100mm
- GM 82-4567 350x170x65mm
- GM 82-4568 400x200x100mm



Electric Sterilizer
GM 82-4569
280x125x65mm

- GM 82-4570 125x80mm
- GM 82-4571 125x120mm
- GM 82-4572 150x100mm
- GM 82-4573 150x150mm
- GM 82-4574 180x180mm
- GM 82-4575 190x140mm
- GM 82-4576 190x190mm
- GM 82-4577 200x200mm
- GM 82-4578 240x120mm
- GM 82-4579 240x240mm
- GM 82-4580 290x140mm
- GM 82-4581 290x240mm
- GM 82-45GM 82 290x290mm
- GM 82-4583 340x160mm
- GM 82-4584 340x340mm
- GM 82-4585 390x150mm
- GM 82-4586 390x200mm
- GM 82-4587 390x290mm



Sterilizer Drum

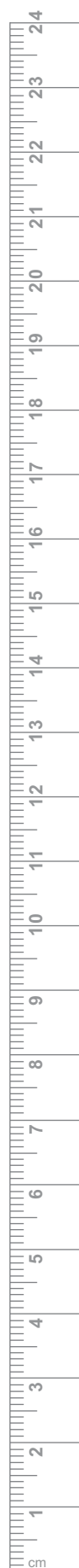



Mohala Mughal Pura, Near Amina Masjid, Gohadpur,
Sialkot 51310, Pakistan.

 0092 309-0222330

 0092 52 4563874

 info@glesco-med.com

 glescomed@gmail.com

 www.glesco-med.com

 glesco-med

 glescomed

 glesco_med

 glescomed

 glesco-med-surgical-077788287